

# LTK-RNG1 | LTK-RNG1-2 | LTK-RNG1-3

Polaris Ranger 1000 XP APEXX Long Travel



Parts Available For These Popular Brands and Others

**POLARIS**

**can-am**



**Kawasaki**



## HIGHLIFTER



[sales@highlifter.com](mailto:sales@highlifter.com)



800-699-0947 | 8:00am - 6:00pm CST



780 Professional Drive North, Shreveport, LA 71105



[www.highlifter.com](http://www.highlifter.com)

## **PRODUCT DISCLAIMER**

The installation of products sold or manufactured by High Lifter Products, Inc. including, but not limited to suspension components such as lift kits, gear reduction lifts, frame stiffener kits, snorkels, and tires that exceed the original specifications for the vehicle, may change the vehicle's center of gravity and handling characteristics both on- and off-road. You are aware that the installation of tires that are larger than original vehicle specifications may reduce the effectiveness of the braking system. Use of these products may place added stress to the original factory vehicle components which could cause them to weaken or possibly fail.

Products sold or manufactured by High Lifter Products, Inc. are intended for off-road use only. Operation of a vehicle modified with these products on a road could result in serious bodily injury or death, and such operation may violate the laws of your state or municipality. You agree to operate your vehicle exclusively in the manner intended by the vehicle manufacturer. You agree that failure to safely and reasonably operate your vehicle could result in serious bodily injury or death, and that, as a result of installation of this product(s) to your vehicle, extreme care must be taken to prevent vehicle rollover or loss of control, which may be more likely to occur as a result of said modifications. You will avoid unsafe maneuvers, including sudden sharp turns or other abrupt maneuvers, which could make a vehicular accident more likely. You understand that High Lifter Products, Inc. is not responsible or liable for any damages or any injuries to yourself or your passengers that could occur upon possible accidents due to driver error, incorrect installations, bad judgment, incompatibility with other aftermarket accessories or natural disasters to the fullest extent allowable by law.

You will have all vehicle occupants fasten seatbelts, if equipped, and wear proper safety equipment, such as DOT approved helmet and eye protection prior to operating the vehicle. You understand and acknowledge that failure to wear proper safety equipment may increase the risk of serious bodily injury or death to yourself and any passengers.

Proper installation of products sold or manufactured by High Lifter Products, Inc. requires knowledge of the factory recommended procedures for removal and installation of original equipment components. Installation of these products without proper knowledge and experience may affect the performance of these components and the safety of the vehicle and cause serious bodily injury or death. It is strongly recommended that a certified mechanic familiar with the installation of similar components perform the product(s) installation.

Prior to installing any products sold or manufactured by High Lifter Products, Inc., you will perform or cause to be performed an inspection of their vehicle to confirm its condition is suitable for the installation of these products. A proper inspection of the vehicle includes confirmation that the vehicle has not been in a collision and is free of corrosion. If the vehicle is suspected to have been in a collision or misused, or is otherwise unsuitable for modification, you will not install the product(s). You will continue to inspect the vehicle prior to each use to confirm its condition is suitable for its intended use, and you acknowledge that the failure to do so may result in serious bodily injury or death, as well as damage to the vehicle itself.

You will install any warning labels provided with the product so it may be prominently seen by yourself and all passengers. You will notify all passengers of the modifications performed to your vehicle prior to operation.

Insurance companies may handle coverage of a modified vehicle differently. Please check with your insurance carrier prior to modifying the vehicle to ensure your coverage remains sufficient.

Installation of this product(s) may void your vehicle warranty. If this is a concern, please check with the manufacturer or dealer before purchase or installation of this product(s).

# HIGHLIFTER

## PARTS DIAGRAM

### LIFT BRACKETS & HARDWARE

(LT-P001-B1)

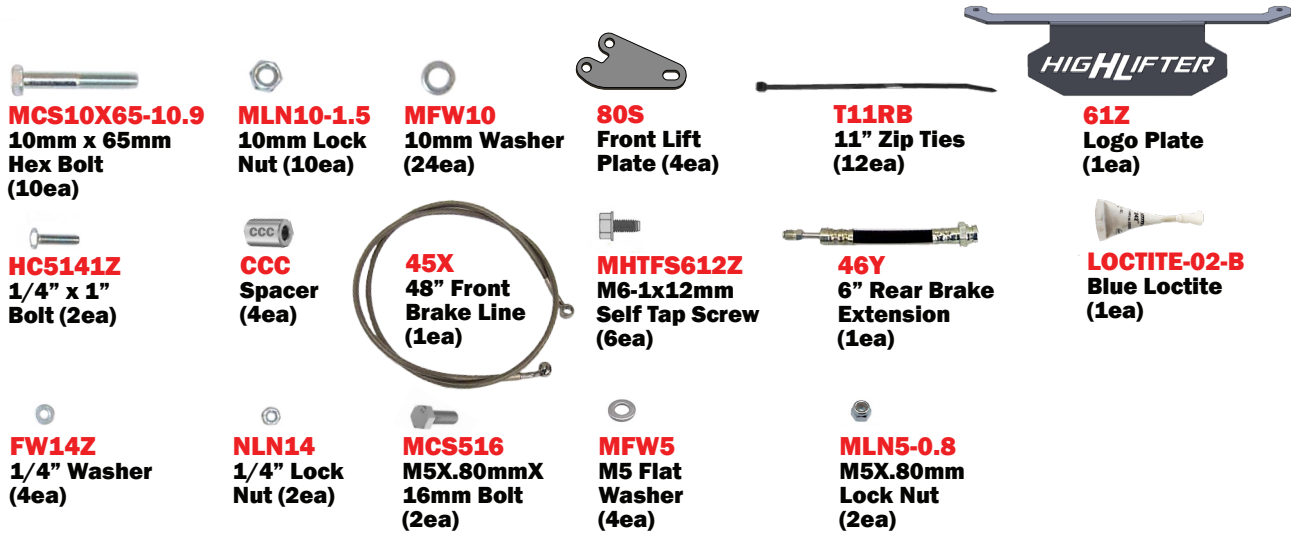

### TIE ROD & STEERING SET UP

(LT-P001-B4)

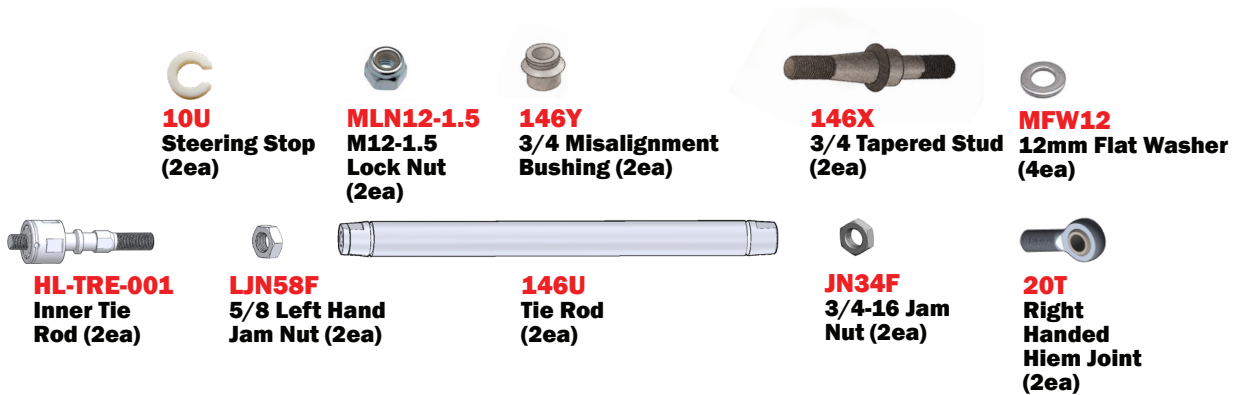

### AXLES (DHT-XL)



Front Axle  
(2ea)



Rear Axle  
(2ea)

**RNG1 (2018-2020)**

Front

DHT-X-RZR1-F

Rear

DHT-XL-RNG1- 2-R

**RNG1-2 (2020 HLE) & RNG1-3 (2021 XP & Special)**

Front

DHT-X-RZR1-1-F

Rear

DHT-XL-RNG1- 2-R

# HIGHLIFTER

PARTS DIAGRAM

## LTK-RNG1 | LTK-RNG1-2

### FRONT LOWER & UPPER ARMS

(LT-P001-B2) 2018-2020

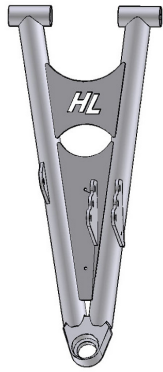

**129A-L**  
Front Upper  
Left Control  
Arm (1ea)



**112K**  
Adjustable  
Collar  
(4ea)

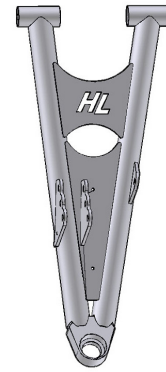

**129A-R**  
Front Upper  
Right Control  
Arm (1ea)



**128Q-L**  
Front Lower Left  
Control Arm (1ea)



**128Q-R**  
Front Lower Right  
Control Arm (1ea)

### REAR LOWER & UPPER ARMS

(LT-P001-B3) 2018-2020

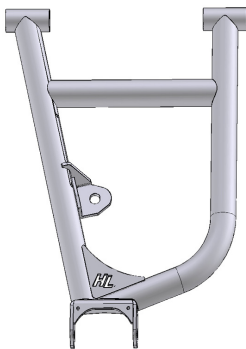

**130T-L**  
Rear Upper  
Left Control  
Arm (1ea)



**112K**  
Adjustable  
Collar  
(4ea)

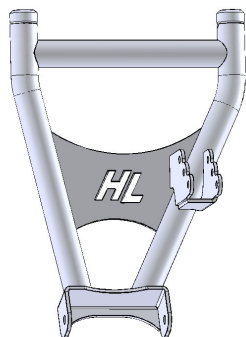

**129J-L**  
Rear Lower  
Left Control  
Arm (1ea)

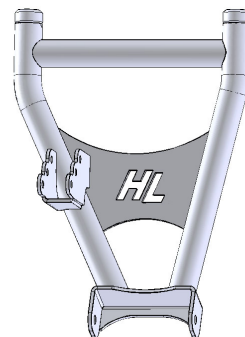

**129J-R**  
Rear Lower  
Right Control  
Arm (1ea)

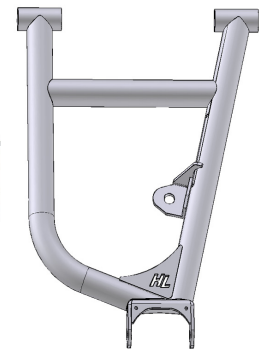

**130T-R**  
Rear Upper  
Right Control  
Arm (1ea)

# HIGHLIFTER

PARTS DIAGRAM

## LTK-RNG1-3

### FRONT LOWER & UPPER ARMS

(LT-P002-B2) 2020+



**107Z**  
Adjustable  
Collar  
(4ea)

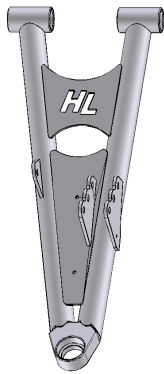

**143V-L**  
Front Upper  
Left Control  
Arm (1ea)

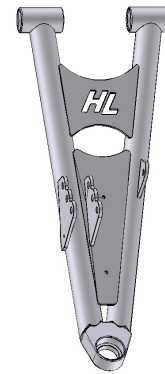

**143V-R**  
Front Upper  
Right Control  
Arm (1ea)



**144D-L**  
Front Lower Left  
Control Arm (1ea)



**144D-R**  
Front Lower Right  
Control Arm (1ea)

### REAR LOWER & UPPER ARMS

(LT-P002-B3) 2020+



**96M**  
Adjustable  
Collar  
(4ea)



**JN1F**  
Jam Nut  
(4ea)

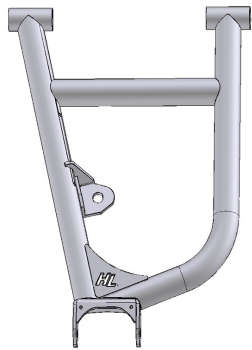

**130T-L**  
Rear Upper  
Left Control  
Arm (1ea)

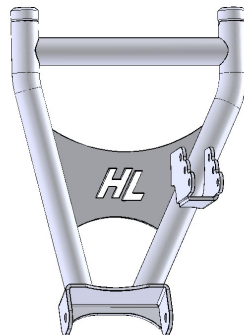

**129J-L**  
Rear Lower  
Left Control  
Arm (1ea)

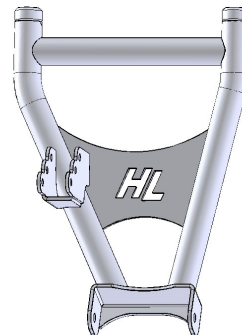

**129J-R**  
Rear Lower  
Right Control  
Arm (1ea)

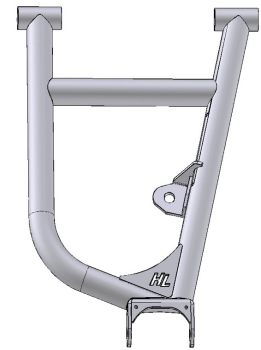

**130T-R**  
Rear Upper  
Right Control  
Arm (1ea)

# Front INSTALL

REMOVING STOCK COMPONENTS

Wheels

1



## FRONT PASSENGER SIDE

**KEEP ALL FACTORY HARDWARE.**

Place **jack** under the **FRONT center** of the UTV and lift until the weight is off the suspension. Ensure that the vehicle is properly secured, so that it is stable on the jack.

Make sure that the jack is tall enough to raise the UTV high enough to reinstall the tires after the lift is installed.

**Remove the front wheels.**

REMOVING STOCK COMPONENTS

Brake Lines & Caliper

2

UPPER ARM



FRAME



CALIPER

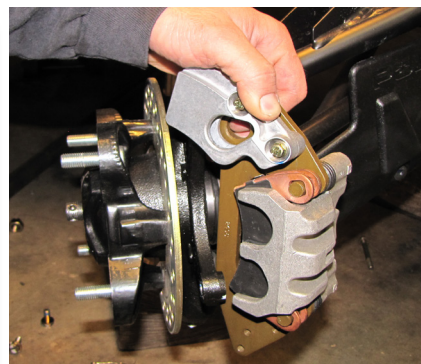

Disconnect the **brake lines** from arms and frame. Remove the **(2) brake caliper mounting bolts (15mm)** **DO NOT** disconnect lines from caliper. Set brake caliper aside.

REMOVING STOCK COMPONENTS

Hub Assembly

3

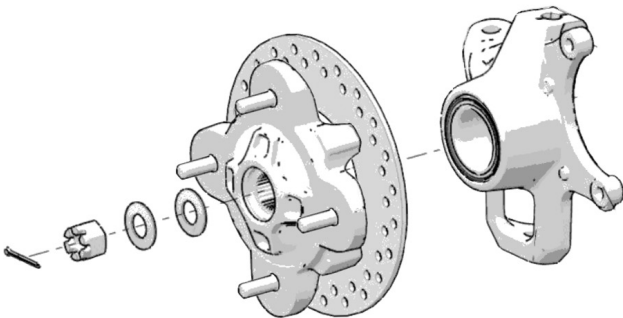

Remove the **cotter pin**, **axle nut**, and **washers** from the hub assembly, then remove the hub. **(27mm)** **KEEP FACTORY HARDWARE.**

6

**REPEAT STEPS ON OPPOSITE SIDE**

4

Before removing the upper and lower arms from the front hub assembly, you will first need to disconnect:

- A. Tie rod
- B. Lower sway bar link end
- C. Lower shock end
- D. Upper & Lower Ball joint

LOWER SWAY BAR LINK END

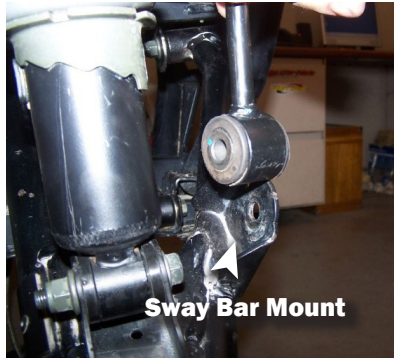

LOWER SHOCK END



TIE ROD END

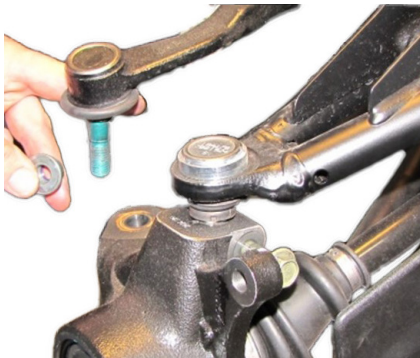

Disconnect the **tie rod** from the knuckle. (18mm)

UPPER BALL JOINT



Disconnect the **Upper ball joint** by removing the **bolt** at the knuckle. (15mm)

LOWER BALL JOINT



Disconnect the **Lower ball joint** by removing the **bolt** at the knuckle. (15mm)

5

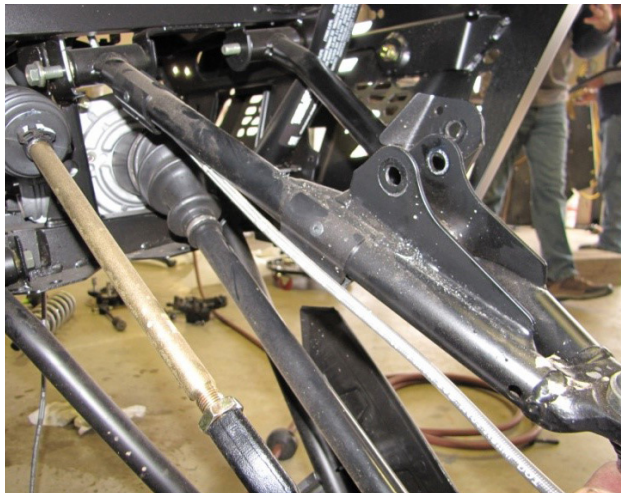

Remove the **Upper and Lower arms** by removing the **bolts** from the **frame**. (18mm) Then remove the **stock axle**. **KEEP ALL FACTORY HARDWARE.**

**REPEAT STEPS ON OPPOSITE SIDE**

6

**NOTICE: DO NOT remove the pinion. The images featured are for DEMONSTRATIVE PURPOSES ONLY.**

**BOOT REMOVAL**

The rubber boots on the rack and pinion are held on by zip ties. You will need to cut the zip tie that secures the boots to the inside of the rack and pinion.

**START WITH THE DRIVER'S SIDE**

This side has the least amount of room. Once you install the spacer on the passenger side you will have less play on the driver's side. **DO NOT REMOVE THE FACTORY SPACER ALREADY IN PLACE.** Turn the steering wheel all the way to the **RIGHT**.

**PASSENGER SIDE**

Turn the steering all the way to the left. Place the steering stop (10U) between the inner tie rod joint and the rack and pinion. It is a tight fit, so you may have to force it on, this is to ensure that the spacer stays in place.

**RESECURING BOOT**

you will need to turn the steering wheel closer to the center to allow play in the boot. Slide the boot back down and secure it with an 11" zip tie.

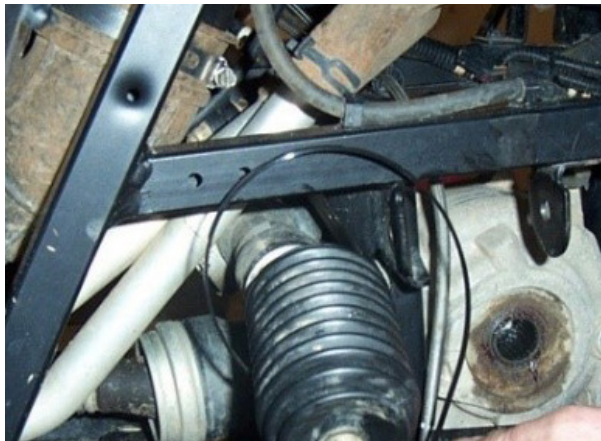
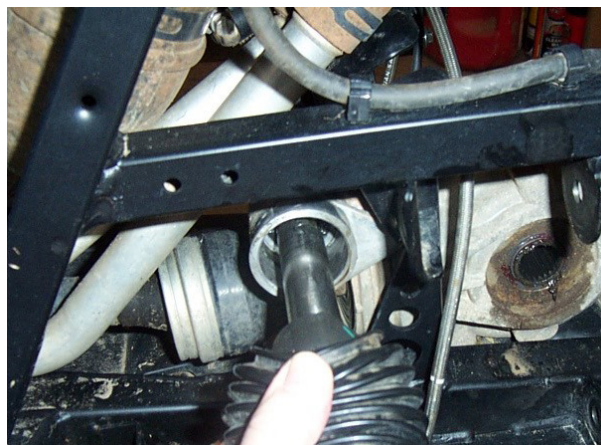
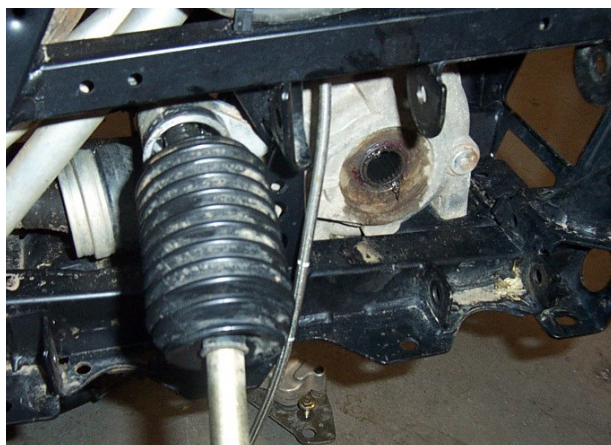
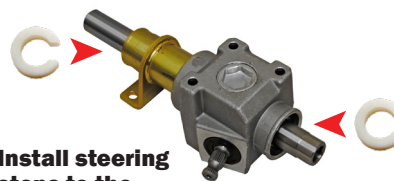



## 7 IF YOU ORDERED PRE-INSTALLED ARMS SKIP TO STEP 10

**IF YOU HAVE ACCESS TO A BLIND BEARING PULLER WE HIGHLY RECOMMEND USING THIS TOOL OVER THIS METHOD. USING A PUNCH MAY CAUSE DAMAGE TO THE BUSHINGS.**

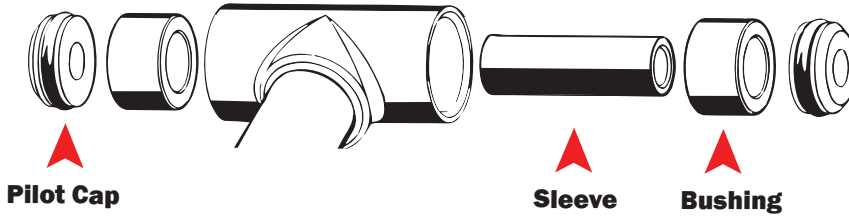

## UPPER ARM

**Remove pivot caps and sleeves from both arms**

**Use a blind bearing puller or a flat punch to remove the bushings.**

**Use caution when removing the bushing from the collar, there is a stop built into the factory arm that prevents the bushing from pushing out when installed. Because of this, the bushing must be pushed out from the opposite side.**



**You will need to reuse your factory pivot caps, bushings, sleeves, and ball joints. Make sure that you inspect your bushings and ball joints for wear. Replace as needed.**

## 8

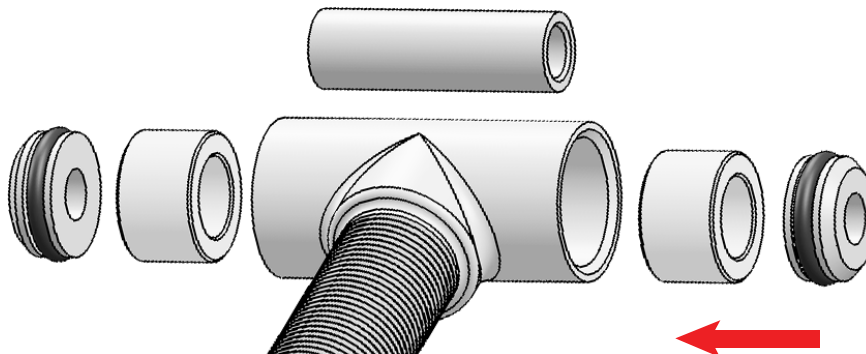

**Once the bushing is inserted, use a socket, of the same diameter as the bushing to press it in all the way.**

**Applying grease to the bushings and sleeves will make the installation easier.**

**Use a press or vice to secure the bushings.**

9

**IF YOU HAVE PRE-INSTALLED BALL JOINTS SKIP TO STEP 12**

**NOTE: A press or a vise is suggested for removing and replacing the ball joints.**



10

**Flip the control arm over, and using the same process, press the ball joint in using a vice or press. If you press in the ball joint crooked, DO NOT TRY TO FORCE IT IN! If you try to force it straight you can "egg" the opening. Press the ball joint out and reinsert it into the opening, pressing it in with a vise. Verify that the clip snaps into place after installing the ball joints into the new Control Arm. You should always double check the ball joint snap ring for proper fit. Even if you use snap ring pliers, it may not seat. You can use a flathead screwdriver and a hammer to tap the snap ring to ensure that it is seated into the groove.**

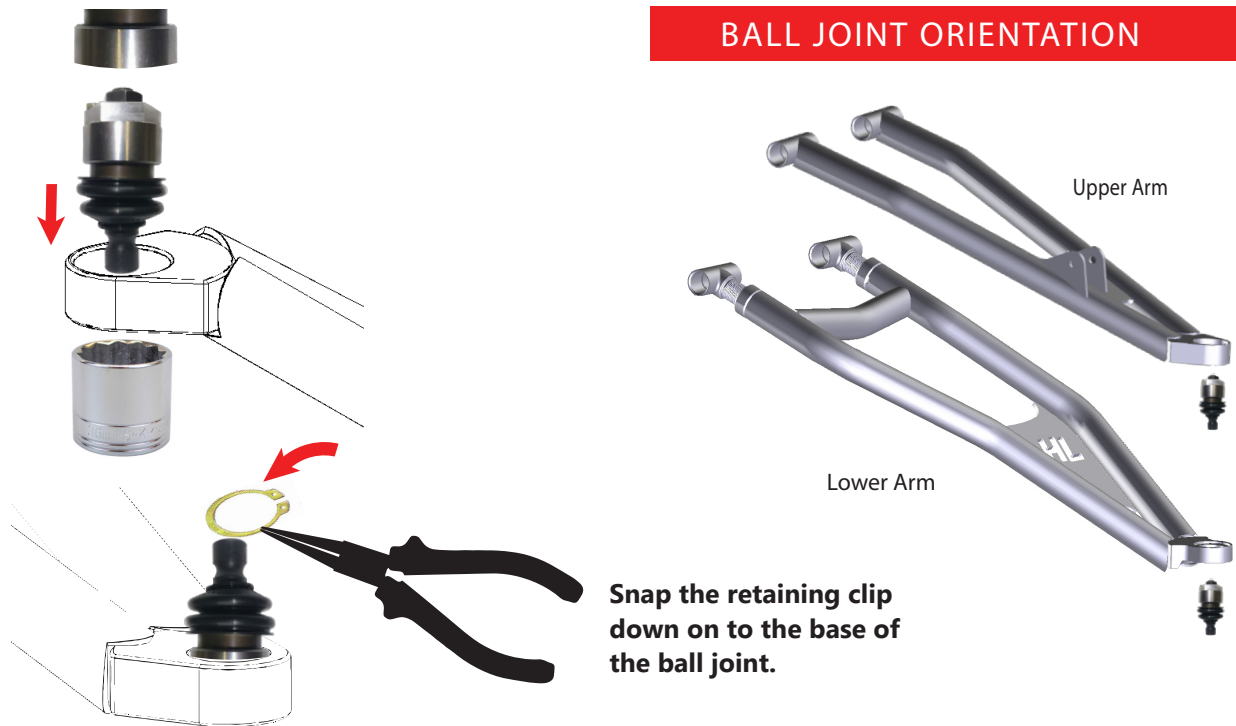

11

## PASSENGER SIDE

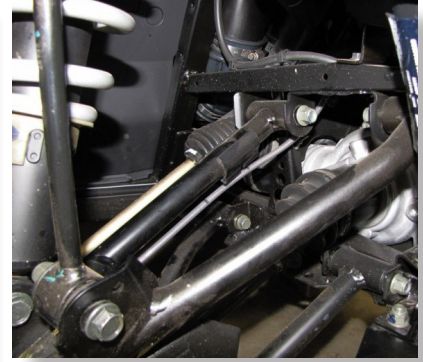

Disconnect the brake line from the caliper and upper control arm. Have a container ready to collect brake fluid.

## DRIVERS SIDE

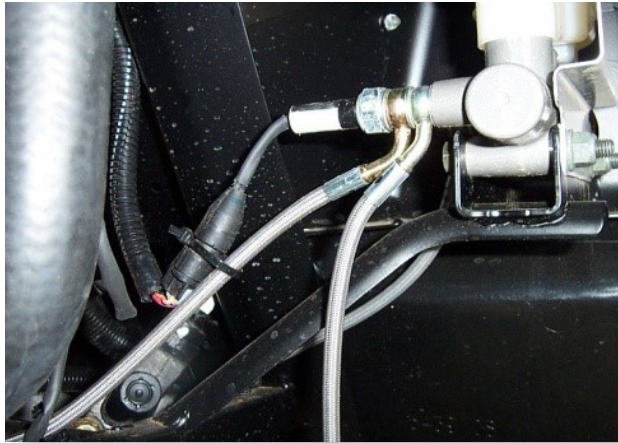

Locate the master cylinder on the (DR) side.



Unplug the connector.



Disconnect the banjo bolt and brake lines from the master cylinder. Have a container ready to collect brake fluid.



Save the factory washers that separate the two front lines. Remove the line from the UTV.

## 12 PASSENGER SIDE



**Install the new longer 48" brake line (45X) on the right side of the UTV.**



**Route the line back through to the right front control arm.**

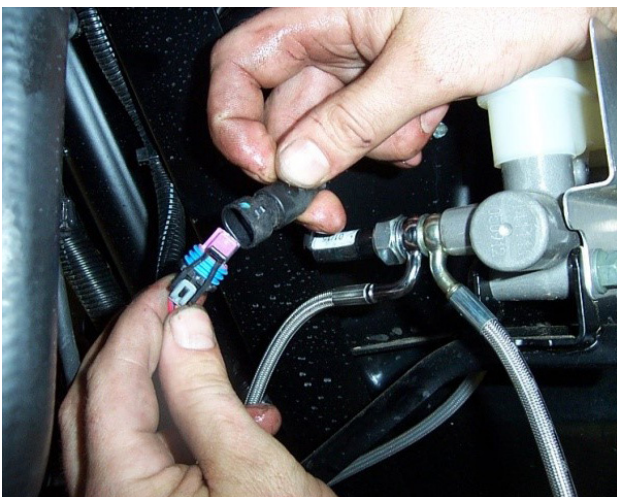

**Use the right factory brake line that you removed to replace the left factory brake line. The left factory line will not be long enough once the new control arms are installed. Then connect all the lines back to the master cylinder using the factory hardware.**

## 13

**REMOVE THE SHOCKS IF YOU HAVE NOT DONE SO ALREADY.**



Install the **(80S)** bracket between the stock shock location by inserting the **10mm x 65mm** bolt through the upper portion of the bracket.



Insert the **(CCC)** spacer between the bracket and tab, then run the bolt through.



**DO NOT** secure hardware yet.



Install the **(CCC)** spacer and **10mm x 65mm** bolt on the lower portion of the bracket.



Place the corresponding bracket **(80S)** on the back side of the tabs.

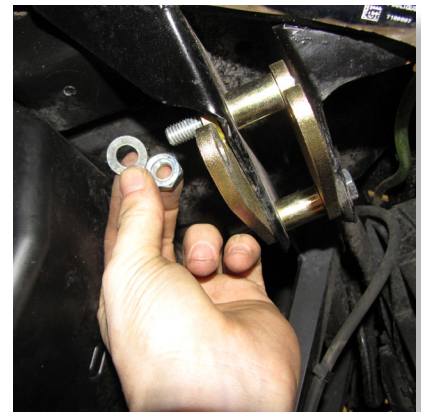

Secure the new shock mount bracket by installing a **10mm** washer and **10mm** lock nut to both bolts.

**REPEAT STEPS ON OPPOSITE SIDE**

14

## MODIFICATIONS

**INNER TIE ROD (HL-TRE-001)  
(LEFT HAND THREADED)**

**HEIM JOINT (20T)  
(RIGHT HAND THREADED)**



**LEFT HAND THREADED**

**RIGHT HAND THREADED**

Scribe Line ➔

No Line

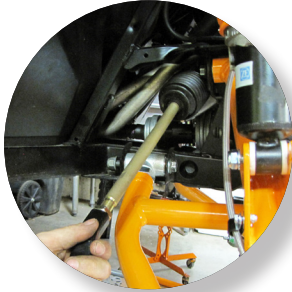

Remove the clamp from the boot, then remove the stock tie rod.



Install the boot over the (HL-TRE-001) inner tie rod, then thread on the (146U) tie rod to the inner tie rod end.



Install the heim joint (20T) and to the opposite end. This will likely need to be adjusted later.

15

USE A GRINDER FOR THESE NEXT STEPS.

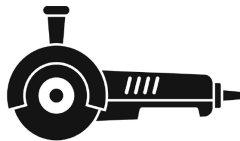

### BUMPER

### FRAME

**BEFORE**

**AFTER**



**BEFORE**

**AFTER**

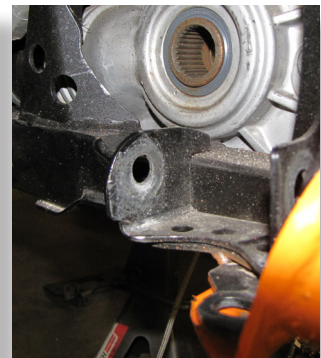
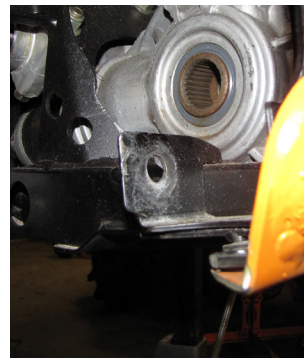

**- FOR MODELS WITH BUMPERS ONLY -**  
BEFORE INSTALLING THE CONTROL ARMS You will need to grind down the BUMPER tab to gain clearance for the new adjustable control arms.

BEFORE INSTALLING THE FRONT AXLES You will need to grind down the right lower FRAME tab to gain clearance for the new axles.

# Front INSTALL

## FRONT LOWER CONTROL ARM

Install

16

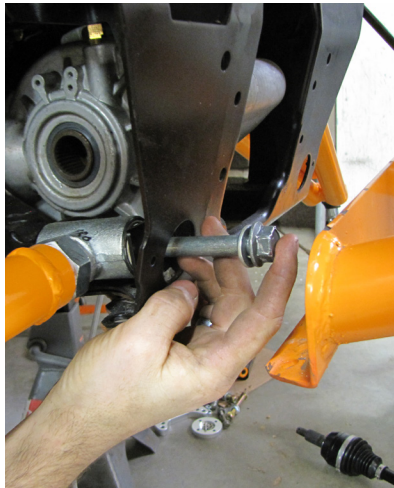

**Connect the lower arm at the frame. You will have to remove the lower bolts to the bumper and pull it back to access the frame bolts. This is easier if you have someone to assist you. Next, install the axle into the front differential, then slide the axle through the hub assembly. Connect the lower arm at the knuckle. Secure with factory hardware. DO NOT FORGET WASHERS.**



## FRONT UPPER CONTROL ARM

Install

17



**Using factory hardware, connect the new upper arm at the frame.**



**Then connect it at the pinch bolt on the knuckle.**



**Insert the 10mm x 65mm bolt through the upper shock lift bracket, then install a 10mm washer and secure it with a 10mm lock nut.**

**REPEAT STEPS ON OPPOSITE SIDE**

18

Set the unit up in a level location. Visually distinguish if the front or rear is higher on one end than the other. Using the different shock tab locations, adjust the shock until the unit appears level.



### SHOCK ADJUSTMENT

**Outer:** Setting the shock at this location will **HIGHTEN** the unit.

**Center:** Setting the shock at this location will keep the unit **NEUTRAL**.

**Inner:** Setting the shock at this location will **LOWER** the unit.

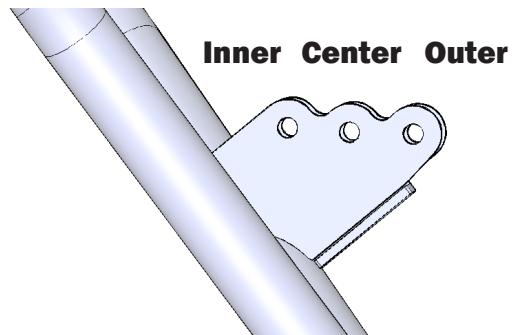

### SHOCK

Insert the **10mm x 65mm bolt** and **10mm washer** through the **lower shock tab**, then install another **10mm washer** followed by a **10mm lock nut**.

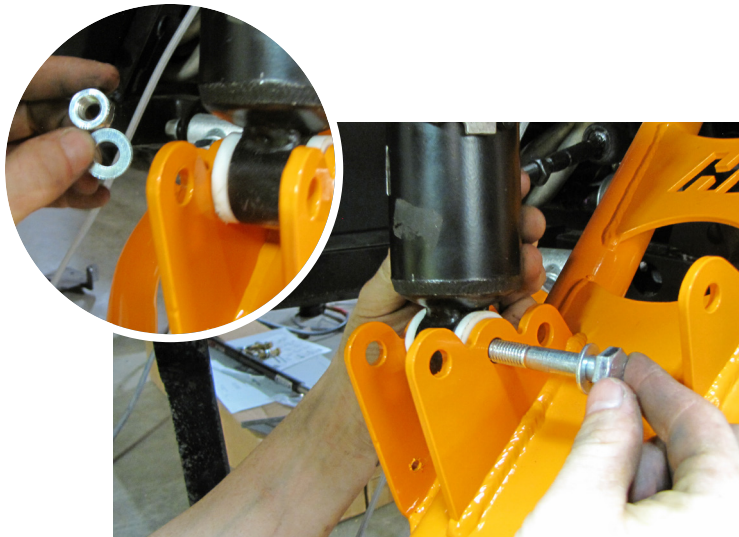



# Front INSTALL

## FRONT BRAKE & HUB ASSEMBLY

Install

19

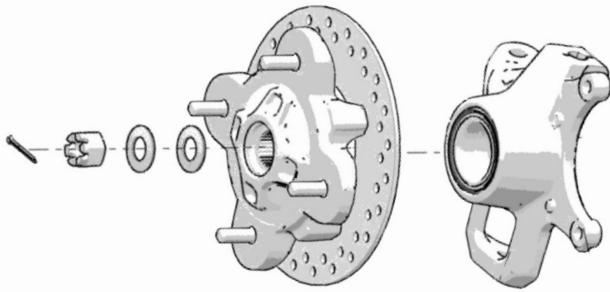

Reattach the rotor to the knuckle assembly.

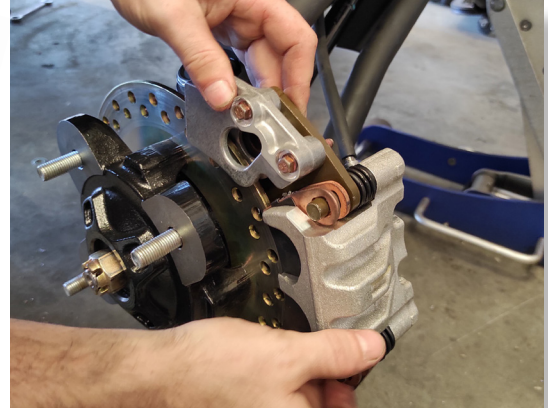

Connect the caliper to the hub assembly.

## FRONT BRAKE LINES

Install

20

### UPPER CONTROL ARM

Route the brake lines along the back of the upper arm and under, so that the lines do not come in contact with moving parts or become pinched. Fasten lines to the FRAME and UPPER ARM.

#### CONTROL ARM

Secure the brake line to the upper arm with a p-clamp and a 5x16mm bolt followed by a 5mm washer. Secure the bolt with another 5mm washer and a 5mm lock nut.

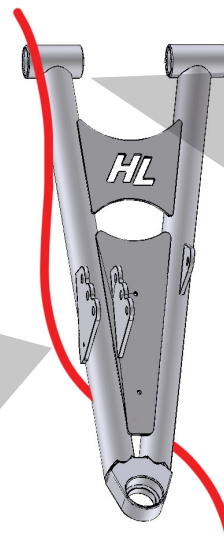

FRAME



Secure brake line to frame with a p-clamp and factory hardware. (T25)

## TIE ROD END

Install

21

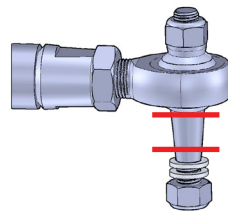
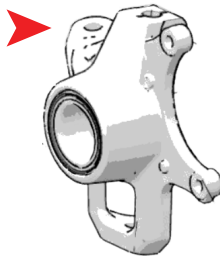
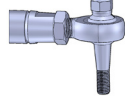
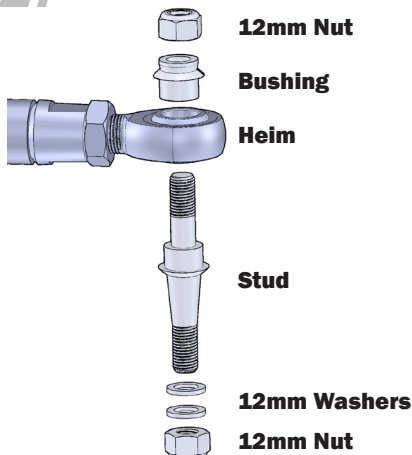

Tie Rod Tab placement

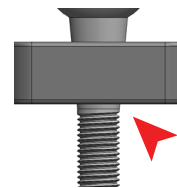

Slide the 3/4 tapered stud 146X through bottom of the heim joint (20T), place the 3/4 bushing (146Y) on the top side of the stud. Insert the stud on the TOP SIDE through the tie rod tab on the knuckle. Slide (2) 12mm washers on the bottom end of the stud. Fasten with a 12mm lock nut on each end. THE TIE ROD ADJUSTMENT INSTRUCTIONS ARE ON PAGE 26.

Part 146X is a universal tapered stud. On some applications it may require the use of additional washers, so that the nut can properly secure the stud. If your application allows any of the tapered portion of the part to extend past the bracket on the nut side use additional washers.

REPEAT STEPS ON OPPOSITE SIDE

# Rear INSTALL

REAR LIFT

Install

22



## REAR PASSENGER SIDE

**KEEP ALL FACTORY HARDWARE.**

Place **jack** under the **REAR center** of the UTV and lift until the weight is off the suspension. Ensure that the vehicle is properly secured, so that it is stable on the jack.

Make sure that the jack is tall enough to raise the UTV high enough to reinstall the tires after the lift is installed.

**Remove the rear wheels.**

REAR BRAKE LINES

Removal

23

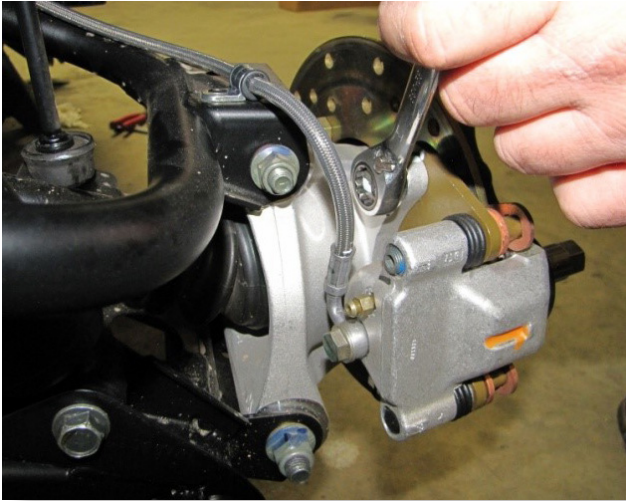

**Disconnect the caliper bolts from the hub assembly, leave the brake line attached to the caliper (15mm). Set brake caliper aside. KEEP FACTORY HARDWARE.**

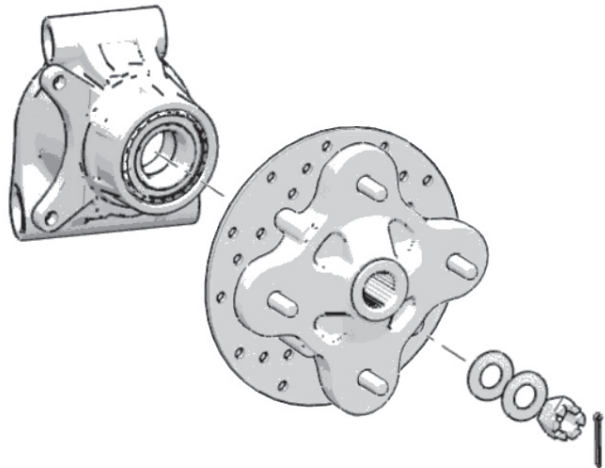

**Remove the factory cotter pin and castle nut (27mm) on the rear axles, then remove the brake rotor assembly.**

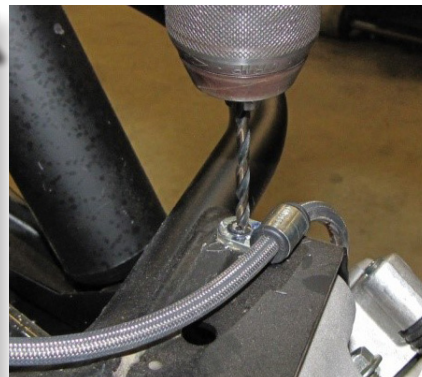

**Drill out the factory p-clamps until they snap off, then remove the clamps from the upper arm.**

18

**REPEAT STEPS ON OPPOSITE SIDE**

# Rear INSTALL

## 24 LOWER ARM

Disconnect the lower arm **FIRST** by detaching the arm at the hub, then disconnect the lower shock, sway-bar, and frame bolts. The factory hardware will be used to reconnect the new control arms.

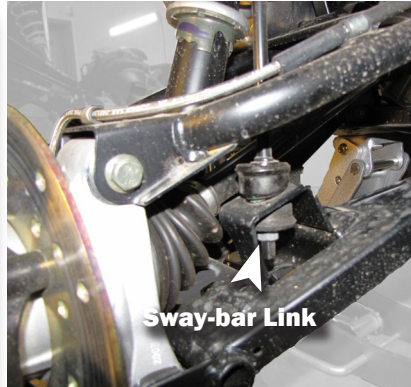
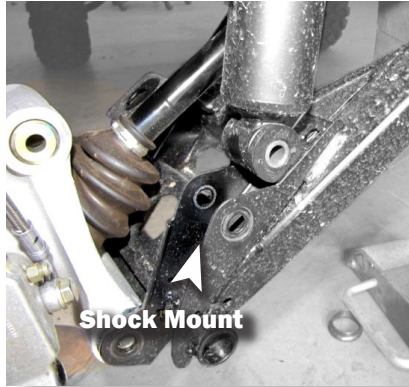

## 25 UPPER ARM

For Northstart and High Lifter editions, remove the exhaust. This will help gain access to the upper control arm bolt.

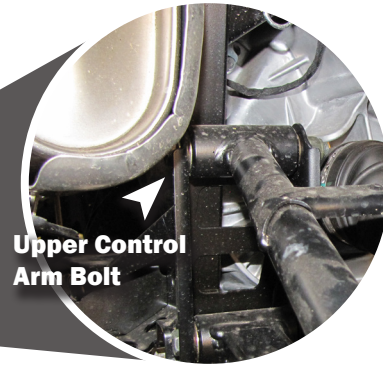
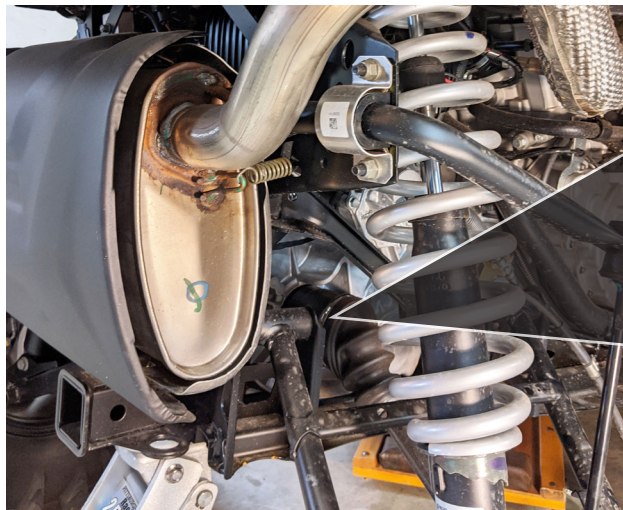

Remove the upper control arm and stock axles at this time. **KEEP FACTORY HARDWARE. SET ARMS ASIDE FOR BUSHING REMOVAL.**

**REPEAT STEPS ON OPPOSITE SIDE**



# IMPORTANT NOTICE

## 2021 RANGER 1000 XP BUSHING INSTALL

If you have a **2021 model Ranger**, the factory bushings will need to be reused and installed on the **(2021) 96M** collar included. Complete the following instructions included for proper bushing install. If you **DO NOT** have a 2021 model, discard this notice and continue with the master instructions.

### REMOVE FACTORY BUSHINGS

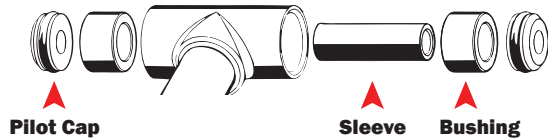

- Remove **pivot caps and sleeves** from both factory arms, set aside.



- Use a **blind bearing puller or a flat punch to remove the bushings. WE RECOMMEND USING A BEARING PULLED OVER A PUNCH. USING A PUNCH MAY CAUSE DAMAGE TO THE BUSHINGS.**

- Once **bushings** are removed **set them aside to be reused on the new HD adjustable arms.**



**CAUTION:** There is a stop built into the factory arm that prevents the bushing from pushing out when installed. Because of this, the bushing must be pushed out from the opposite side.

### 96M BUSHING INSTALL

- Once a bushing is inserted, use a socket or spacer of the same diameter as the bushing to press it in all the way. Applying grease to the bushings and sleeves will make the installation easier.

- Use a **press or vice to seat bushings.**

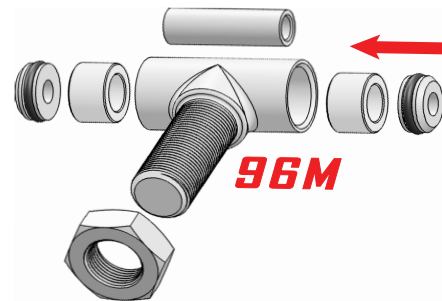

### THREAD ON TO ARM

- Once installed, **thread the jam nuts onto the (2021) 96M collars. Secure them to the HD adjustable control arms. REFER TO MAIN INSTRUCTIONS FOR CAMBER INFORMATION AND TORQUE SPECIFICATIONS.**



Should you have any questions about the High Lifter Control Arms for the 2021 Polaris Ranger, please give us a call at **800-699-0947**.

26

## LOWER ARM



Install the new lower control arm to the frame, using the factory hardware. **DO NOT FORGET WASHERS.**

## AXLE



Install the new rear axles into the differential.



27

## UPPER ARM

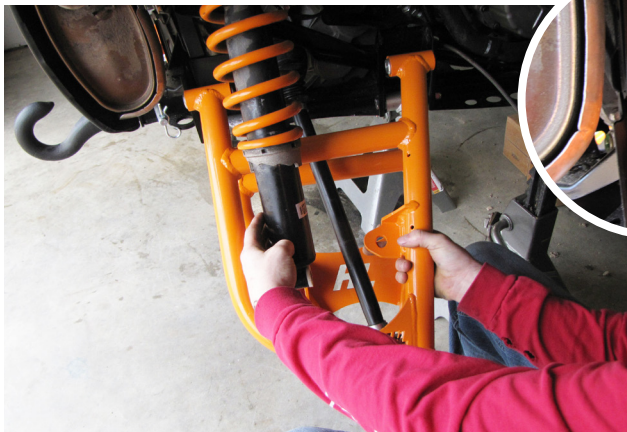

Install the new upper control arm to the frame, using the factory hardware. **DO NOT FORGET WASHERS.**

**WHEN SECURING THE UPPER ARM TO THE LEFT FRAME TAB, INSTALL THE BOLT FROM THE RIGHT SIDE TO EASE FUTURE MAINTENANCE.**

(If installed from the opposite direction, the exhaust will continue to block bolt removal)

28

## SWAY BAR



Insert the sway-bar link through the mount on the lower arm. secure it with the rubber bushing.



**REPEAT STEPS ON OPPOSITE SIDE**

## Rear INSTALL

29

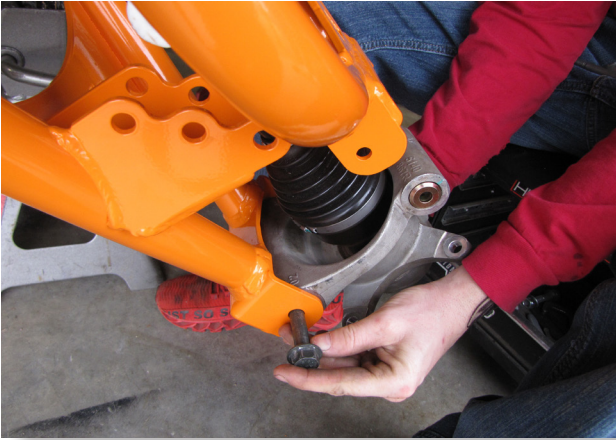

slide the axle into the hub assembly. Connect the upper and lower arms to the hub assembly using the factory hardware.

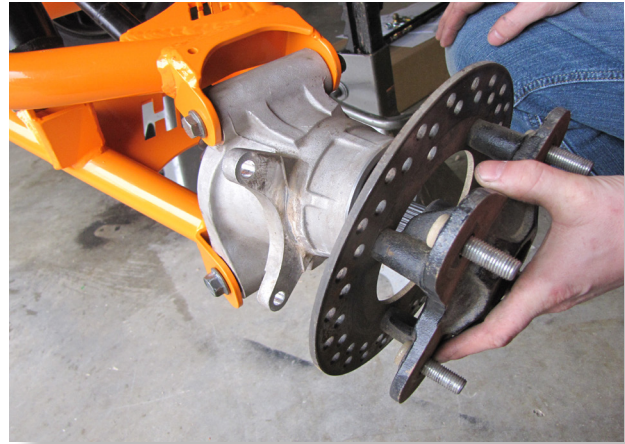

Place the rotor onto the hub and axle assembly.

30

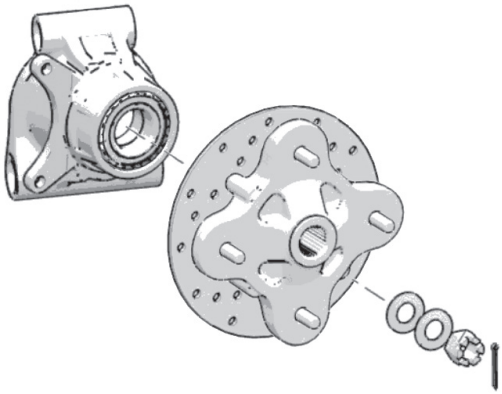

Fasten the rotor using the axle washers, castle nut, and cotter pin provided in the kit.

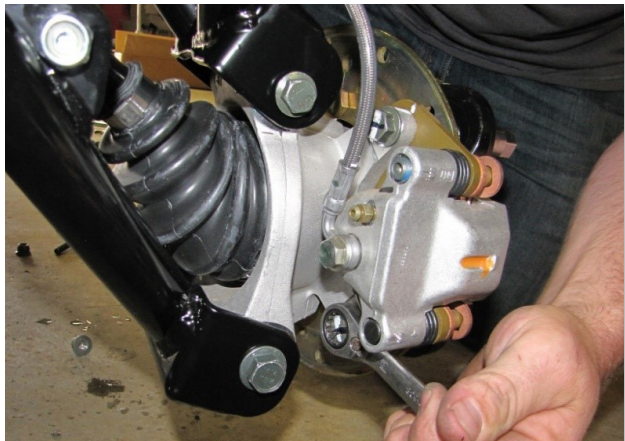

Fasten the calipers to their hubs. (15mm)

31

## REAR DRIVER SIDE

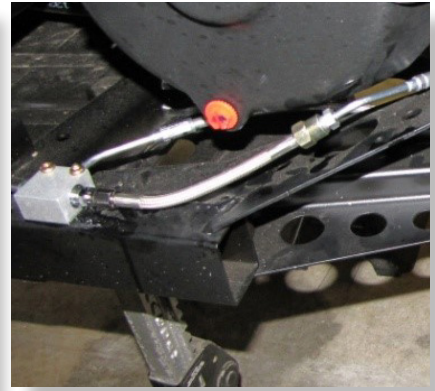
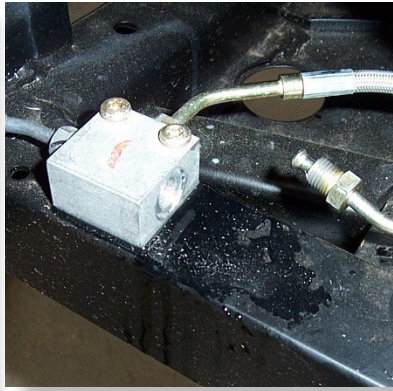
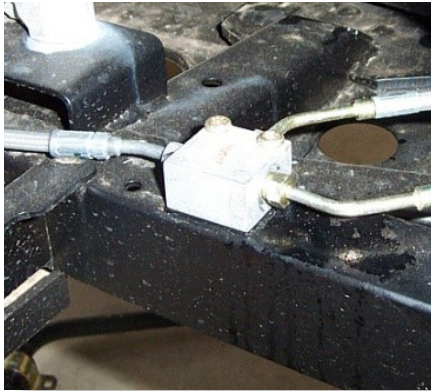

Locate the brake line junction block on the rear driver side or left side of the frame. Disconnect the **REAR DRIVER SIDE** line from the junction block. Connect the new 6" extension (46Y) to the brake line and then to the junction block.



6" Extension (46Y)

**NOTE:** This may require disconnecting the line from the factory clamps and re-routing it. Ensure the line isn't pinched or in contact with moving parts.

**STEPS FOR BRAKE BLEEDING CAN BE FOUND ON PAGE 25.**

## REAR PASSENGER SIDE

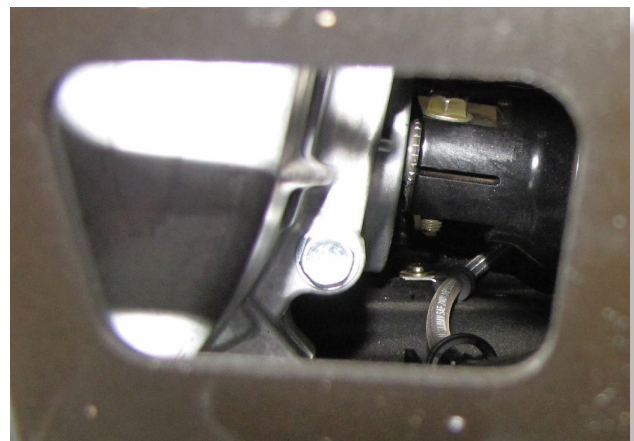

Run the slack out where the brake line runs under the rear differential. Make sure the line is still running through the (2) clamps attached to the bottom and clear from contacting the rear drive shaft.

**NOTE:** You may need to disconnect the factory p-clamps from the upper control arm as well for additional slack.

**REPEAT STEPS ON OPPOSITE SIDE**

## Rear INSTALL

REAR BRAKE LINES

Routing

32

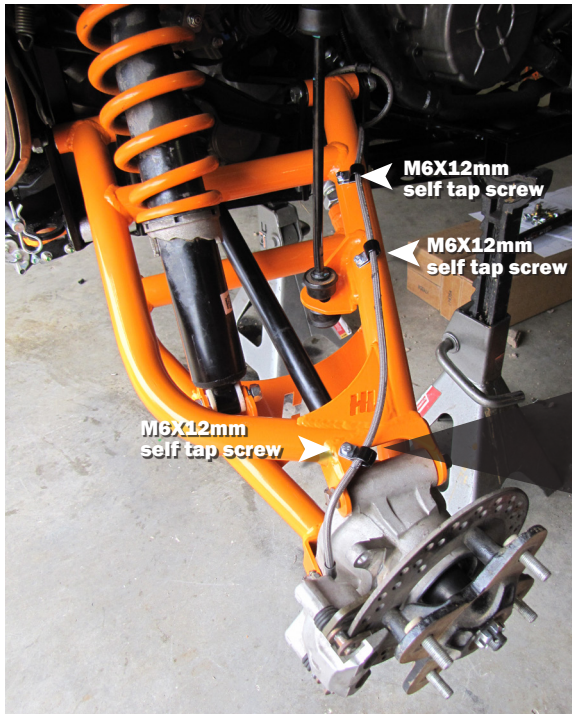

Route the rear brake line to the front of the upper control arm, then secure the line to the arm by using (3) p-clamps and the (3) M6x12mm self tap screws.



LOGO PLATE

Install

33

Lift the bed to gain access to the rear frame bracket.



Disconnect and unclip the wire. Slide the logo plate (61Z) between the frame bracket and the bed.



Slide a (1/4" x 1" bolt) and (1/4" Fasten the bolts with a (1/4" washer) and (1/4" lock nut). Reconnect the wire.





34

**NOTE: USE DOT 4 BRAKE FLUID**

**CAUTION: ALWAYS** wear eye protection like safety glasses. Brake fluid will damage finished surfaces. Do not allow brake fluid to come in contact with finished surfaces.

1. Bleeding the brakes is a two person job; you will need someone at the brake caliper and someone to pump the brake foot pedal. Take precautions due to the vehicle being on jacks and/or jack stands.
2. Clean the master cylinder cover thoroughly and remove the cover.
3. With all bleeder screws open, a gravity bleed is recommended to start with. This will push all the air out at once and eliminate most of the air bubbles. (Have area prepared for spills and cleaning)
4. Add brake fluid to the indicated MAX level of the reservoir. (Any DOT 4 Brake Fluid)
5. Close off each line once you steadily see fluid coming out.
6. Begin final bleeding procedure with the caliper that is the farthest from the master cylinder. It should be this sequence - (PA) REAR, (DR) REAR, (PA) FRONT, and then (DR) FRONT.
7. You can use the supplied clear hose to attach to the caliper bleeder screw. Be sure the hose fits tightly on fitting. Now place the other end of the hose into a clean container.
8. Install a box end wrench on the caliper bleeder screw. Have your brake buddy slowly pump the foot pedal until pressure builds and holds. Have your buddy hold brake pedal down to maintain pedal pressure. Now slowly open the caliper bleeder screw 1/4" turn so the air and fluid will displace into the container.
9. Close bleeder screw, and then have your buddy release the foot pedal.

**NOTE: Do not release foot pedal before the bleeder screw is tight or air may be drawn into the master cylinder... and you have to start all over again!**

10. Repeat steps until clean fluid appears in the bleeder hose & all the air has been purged... Close bleeder screw, pump brakes, hold pressure, open bleeder, close bleeder, release foot pedal, check master cylinder.
11. Check the master cylinder fluid level. **NOTE: You must maintain at least 1/2" (1.27cm) of brake fluid in the reservoir to prevent air from entering the master cylinder.**
12. Tighten bleeder screw securely and remove bleeder hose. Torque the bleeder screw. [4 ft lbs]
13. REPEAT procedure steps for the other three (3) brake calipers in the sequence listed above.
14. Add brake fluid to MAX level inside master cylinder reservoir after the last caliper is completed. Install master cylinder reservoir cover. Check brake system for leaks.
15. Once completed, dispose of used fluid properly.

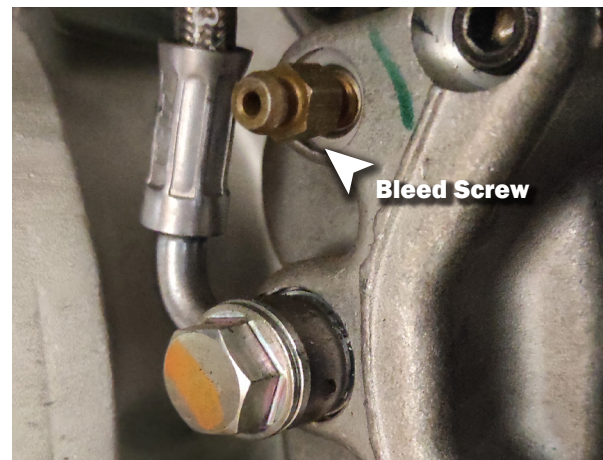

**REPEAT STEPS ON OPPOSITE SIDE**

**DO NOT INSTALL WHEELS ONTO UTV UNTIL PROPER ALIGNMENT HAS BEEN ACHIEVED.**

- Straighten steering wheel
- Make sure that the brake rotors are straight to sight or level.
- Using a tape measure, measure from inside to inside on the front and back ends of the rotors.

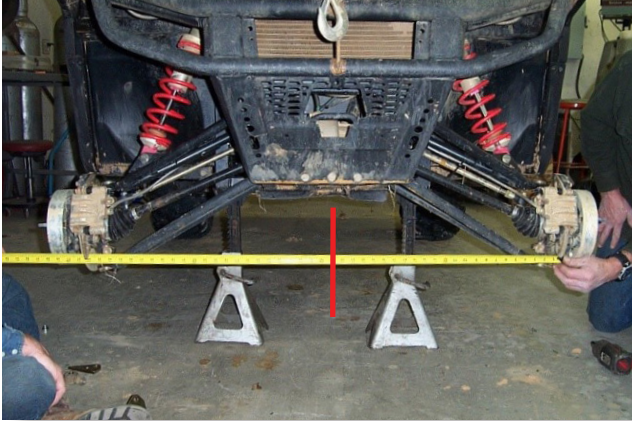

**INCORRECT TOE**

If the toe alignment is incorrect, measure the distance between vehicle center and the back of the rotors. This will indicate which tie rod needs adjustment.

**ADJUSTING TOE**

- Adjust tie rods until **BOTH** measurements are the **SAME**, then adjust toe tolerance.

The recommended vehicle toe tolerance is 1/8" to 1/4" (3.175-6.35mm) toe out. This means the **FRONT MEASUREMENT IS WIDER THAN THE REAR MEASUREMENT.**

**TOE ADJUSTMENT CHART**

<b>TOE (Inches)</b>	1/16	1/8	3/16	1/4	5/16	3/8
<b>TOE (Degrees)</b>	0.12°	0.25°	0.38°	0.51°	0.64°	0.76°

**Recommended Settings**



If the **FRONT OF THE WHEELS** are facing **OUT**, adjust the tie rods **OUT** or **INCREASE the length of the tie rod.**

Measurement at the front of the tires will be **GREATER** than the rear, if the **TOE IS OUT.**



If the **FRONT OF THE WHEELS** are facing **IN**, adjust the tie rods **IN** or **REDUCE the length of the tie rod.**

Measurement at the front of the tires will be **LESS** than the rear, if the **TOE IS IN.**



**IMPORTANT NOTE:** When tightening the tie rod jam nuts, the tie rod ends must be held parallel to prevent rod end damage and premature wear. Damage may not be immediately apparent if done incorrectly.

After alignment is complete, tighten & torque tie rod end jam nuts to specifications. [12-14 ft lbs]

**BEFORE STARTING** 

- Tires must be off the ground
- Tires must have equal air pressure
- Suspension components must be completely assembled

The new High Lifter lower control arms will come pre-adjusted to factory length, which is .937

If you need to re-adjust the collars, place the factory arm and new control arm on a flat surface. Measure from eyelet to center mount on the factory arm, and then adjust the new arms to those lengths.

**NOTE:** When re-adjusting, leave the jam nuts loose. Do not fasten tight until installed on UTV, after all final adjustments have been made.

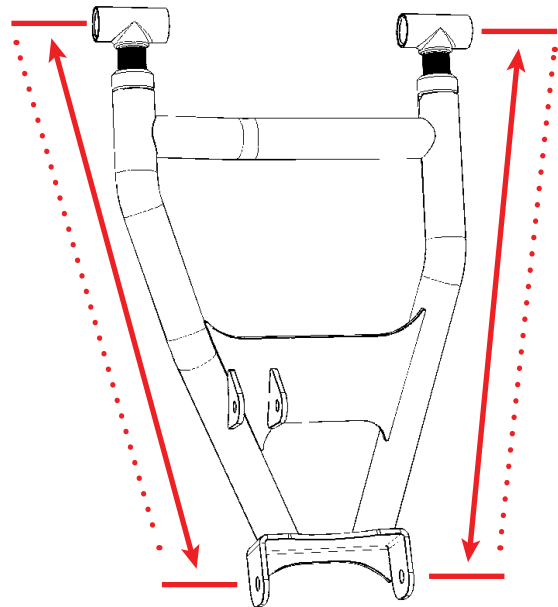

**Positive Camber**

If you have a positive camber you will need to adjust the collar **OUTWARD** or lengthen the control arm. The maximum amount outward is "1.250" which could give up to 3° of positive camber.

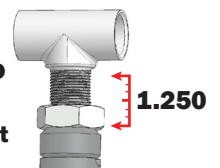

**Zero Camber**

For this application, we recommend a camber setting of 0°. Collars are preset to .937

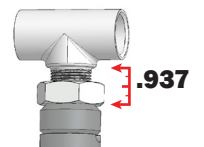

Make all adjustments in small increments.

Do this by disconnecting control arms at the frame and adjusting collars. Once small adjustments have been made. Take the UTV off the jack and roll it back and forth several times to check the camber. Repeat steps as needed. After alignment is complete, tighten jam nuts to 80 ft-lbs and secure it with blue loctite.



**Negative Camber**

If you have a negative camber you will need to adjust the collar **INWARD** or shorten the control arm. The maximum amount inward is zero threads exposed and could give over 3° of negative camber.

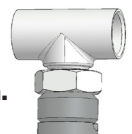

37

**IF YOUR STEERING IS ALREADY CENTERED THEN YOU WILL NOT HAVE TO FOLLOW THESE NEXT STEPS.**

Factory steering for the Polaris Ranger 1000 may **NOT** be centered. This can cause the tie rod ends to have more engagement on one end than the other. This also causes the steering wheel to be off center.



**A)** When the steering is zeroed, check the steering wheel to make sure that it is properly positioned.



**(B)** If the steering wheel is not centered, you will need to remove the center cap with a flat head screwdriver to gain access to the steering wheel nut.



**(C)** Using a ratchet, turn the steering nut counter clockwise or left. Continue this until the steering wheel locks at full turn, then loosen the nut. **Do not** remove the nut yet.



Once the nut is broke, back it off just enough leaving a few threads. Use a hammer to tap on the nut while pulling up on the steering wheel until it breaks loose. But **DO NOT** hammer too hard, it could damage the nut or threads. Now remove the nut and steering wheel.

**NOTE:** A puller may be needed to remove the steering wheel if it can't be broken free.

Now will be the time to adjust the steering wheel accordingly. Re-place the wheel and make sure the wheels are turned back straight. The steering wheel should be straight up and down.

**NOTE:** Rolling vehicle back and forth may help straighten the wheels.

Once the wheel is straight, thread the nut back on and turn the nut clockwise until the steering wheel locks at full turn, then tighten the nut. Reinstall the steering wheel cap.

**NOTE:** Loctite may be needed for the steering nut.

# HIGHLIFTER



## HIGH LIFTER LIMITED LIFETIME WARRANTY

High Lifter offers a Limited Lifetime Warranty to the original purchaser that our product shall be free from defects in material and workmanship for the life of the product if utilized in accordance with the manufacturer's instructions for installation and operation of said products.

### LIMITED LIFETIME WARRANTY EXTENDS TO THE FOLLOWING PRODUCT LINES:

- **Lift Kits (Signature, Standard and Big Lifts)**
- **Control Arms**
- **Trailing Arms**
- **Radiator Relocation Kits**
- **Portal Gear Lifts**
- **Wheel Spacers**
- **Tow Hooks**
- **Control Arm Link Kits**

Damages to vehicle or any other object during the installation, use, or removal of High Lifter products are not covered under this warranty. Normal wear items included with any of the products covered under this Limited Lifetime Warranty are excluded from coverage. These items include, but are not limited to heim joints, tie rods, bearings, bushings, seals, gaskets, zinc plating, painted and powder coated finishes. Other exclusions of coverage under this warranty include, but are not limited to: damage or product failure due to improper installation, lack of maintenance, product modification, abuse, collision or use on vehicles for which product was not designed, repairs performed by anyone other than approved High Lifter personnel or made using non-High Lifter components. This warranty is valid for the original purchaser only and is non-transferable. High Lifter reserves the right to inspect any product before determining if the claim is valid and covered under this warranty. Claims determined to be caused by reasons other than a manufacturer defect will be rejected and an estimate for repair or cost of a replacement product if a repair is not possible, will be provided.

This warranty is exclusive and is in lieu of any implied warranty of merchantability, fitness for a particular purpose or other warranty of quality, whether express or implied, except the warranty of title.

### WARRANTY PROCESSING

If you suspect your product is defective, **DO NOT** disassemble the product to determine the cause without prior approval as it may void your warranty status. This is especially true with our Portal Gear Lift. To begin the claim process, please e-mail our warranty team at [warrantycare@highlifter.com](mailto:warrantycare@highlifter.com) and include the following in the e-mail:

- Your full name, address and contact phone number.
- The year, make and model of your vehicle
- The part number of the product
- Photos of the product installed, and vehicle product is installed on
- Proof of Purchase (Required for all warranty claims and you must be the original purchaser)

Once a claim is created, you will receive a return authorization number (RMA). Write this number on the outside of the box containing your defective product and include it along with your name and contact information inside the box. Product must be returned in the original box or a box of equal strength and packaging. Product sent without an RMA number visible on the outside of the box or sent COD will be refused. Ship your product to the following address:

**High Lifter Products, Inc.**  
**Attn: Returns 780 Professional Dr N Shreveport, LA 71105**

Once your product is received, we often have your replacement or repaired product shipped back to you within 3-business days of receiving it. Please note that High Lifter is not responsible for shipping charges on product returned for warranty or repair, including duties and fees required by those residing outside the United States.

**THANK YOU FOR CHOOSING**  
**HIGHLIFTER**

## DHT-XL LONG TRAVEL AXLE WARRANTY PROGRAM

Thank you for purchasing a High Lifter Products Big Lift equipped with a set of DHT-XL Big Lift Axles. Our axles have been engineered to provide superior performance for use on your ATV/UTV.

### HIGH LIFTER DHT X & DHT XL AXLE 18-MONTH LIMITED WARRANTY

High Lifter offers an 18-Month Limited Warranty to the original purchaser that our DHT X and DHT XL line of axles shall be free from defects in material and workmanship for 18-months following the original purchase date if utilized in accordance with the manufacturer's instructions for installation and operation of said products. In the event of a failure during this 18-month period, High Lifter will replace the axle one time free of charge. Subsequent replacements during this 18-month period will be charged a \$50.00 replacement fee.

### HIGH LIFTER CV AXLE 12-MONTH LIMITED WARRANTY

High Lifter offers an 12-Month Limited Warranty to the original purchaser that our CV line of axles shall be free from defects in material and workmanship for 12-months following the original purchase date if utilized in accordance with the manufacturer's instructions for installation and operation of said products. In the event of a failure during this 12-month period, High Lifter will replace the axle one time free of charge. Subsequent replacements during this 12-month period will be charged a \$50.00 replacement fee.

### HIGH LIFTER STOCK SERIES AXLE 90-DAY LIMITED WARRANTY

High Lifter offers an 90-Day Limited Warranty to the original purchaser that our Stock Series line of axles shall be free from defects in material and workmanship for 90 days following the original purchase date if utilized in accordance with the manufacturer's instructions for installation and operation of said products. In the event of a non-defect related failure during this 90-day period, High Lifter will offer to replace axle for a \$40 replacement fee.

Damages to vehicle or any other object during the installation, use, or removal of High Lifter products are not covered under this warranty. Damage or product failure due to improper installation, lack of maintenance, product modification, abuse, collision or use on vehicles for which product was not designed are also excluded from coverage. Other exclusions of coverage under this warranty include, but are not limited to: damage or product failure due to improper installation, lack of maintenance, product modification, abuse, collision or use on vehicles for which product was not designed, repairs performed by anyone other than approved High Lifter personnel or made using non-High Lifter components. This warranty is valid for the original purchaser only and is non-transferable. High Lifter reserves the right to inspect any product before determining if the claim is valid and covered under this warranty. Claims determined to be caused by reasons other than a manufacturer defect will be rejected and an estimate for repair or cost of a replacement product if a repair is not possible, will be provided.

This warranty is exclusive and is in lieu of any implied warranty of merchantability, fitness for a particular purpose or other warranty of quality, whether express or implied, except the warranty of title.

### WARRANTY PROCESSING

If you suspect your product is defective, **DO NOT** disassemble the product to determine the cause without prior approval as it may void your warranty status. To begin the claim process, please e-mail our warranty team at [warranty@highlifter.com](mailto:warranty@highlifter.com) and include the following in the e-mail:

- Your full name, address and contact phone number.
- The year, make and model of your vehicle
- The part number of the axle
- Photos of the axle installed, and vehicle axle is installed on
- Proof of Purchase (Required for all warranty claims and you must be the original purchaser)

Once a claim is created, you will receive a return authorization number (RMA). Write this number on the outside of the box containing your defective product and include it along with your name and contact information inside the box. Product must be returned in the original box or a box of equal strength and packaging. Product sent without an RMA number visible on the outside of the box or sent COD will be refused. Ship your product to the following address: **High Lifter Products, Inc. Attn: Returns 780 Professional Dr N Shreveport, LA 71105** Once your product is received, we often have your replacement or repaired product shipped back to you within 3-business days of receiving it. **Please note that High Lifter is not responsible for shipping charges on product returned for warranty or repair, including duties and fees required by those residing outside the United States.**



### HIGH LIFTER PRODUCTS DHT-XL AXLE WARRANTY

Name: \_\_\_\_\_

Axle Product Number: \_\_\_\_\_

Address: \_\_\_\_\_

Place of Purchase: \_\_\_\_\_

\_\_\_\_\_

Date of Purchase: \_\_\_\_\_

Phone Number: \_\_\_\_\_

Reason for Return: \_\_\_\_\_

E-Mail Address: \_\_\_\_\_

\_\_\_\_\_