

# HDPLK-DXL-RNG1

Polaris Ranger 1000 XP APEXX Big Lift Kit



Parts Available For These Popular Brands and Others

**POLARIS**

*can-am*



**Kawasaki**



## HIGHLIFTER



[sales@highlifter.com](mailto:sales@highlifter.com)



800-699-0947 | 8:00am - 6:00pm CST



780 Professional Drive North, Shreveport, LA 71105



[www.highlifter.com](http://www.highlifter.com)

## PRODUCT DISCLAIMER

The installation of products sold or manufactured by High Lifter Products, Inc. including, but not limited to suspension components such as lift kits, gear reduction lifts, frame stiffener kits, snorkels, and tires that exceed the original specifications for the vehicle, may change the vehicle's center of gravity and handling characteristics both on- and off-road. You are aware that the installation of tires that are larger than original vehicle specifications may reduce the effectiveness of the braking system. Use of these products may place added stress to the original factory vehicle components which could cause them to weaken or possibly fail.

Products sold or manufactured by High Lifter Products, Inc. are intended for off-road use only. Operation of a vehicle modified with these products on a road could result in serious bodily injury or death, and such operation may violate the laws of your state or municipality. You agree to operate your vehicle exclusively in the manner intended by the vehicle manufacturer. You agree that failure to safely and reasonably operate your vehicle could result in serious bodily injury or death, and that, as a result of installation of this product(s) to your vehicle, extreme care must be taken to prevent vehicle rollover or loss of control, which may be more likely to occur as a result of said modifications. You will avoid unsafe maneuvers, including sudden sharp turns or other abrupt maneuvers, which could make a vehicular accident more likely. You understand that High Lifter Products, Inc. is not responsible or liable for any damages or any injuries to yourself or your passengers that could occur upon possible accidents due to driver error, incorrect installations, bad judgment, incompatibility with other aftermarket accessories or natural disasters to the fullest extent allowable by law.

You will have all vehicle occupants fasten seatbelts, if equipped, and wear proper safety equipment, such as DOT approved helmet and eye protection prior to operating the vehicle. You understand and acknowledge that failure to wear proper safety equipment may increase the risk of serious bodily injury or death to yourself and any passengers.

Proper installation of products sold or manufactured by High Lifter Products, Inc. requires knowledge of the factory recommended procedures for removal and installation of original equipment components. Installation of these products without proper knowledge and experience may affect the performance of these components and the safety of the vehicle and cause serious bodily injury or death. It is strongly recommended that a certified mechanic familiar with the installation of similar components perform the product(s) installation.

Prior to installing any products sold or manufactured by High Lifter Products, Inc., you will perform or cause to be performed an inspection of their vehicle to confirm its condition is suitable for the installation of these products. A proper inspection of the vehicle includes confirmation that the vehicle has not been in a collision and is free of corrosion. If the vehicle is suspected to have been in a collision or misused, or is otherwise unsuitable for modification, you will not install the product(s). You will continue to inspect the vehicle prior to each use to confirm its condition is suitable for its intended use, and you acknowledge that the failure to do so may result in serious bodily injury or death, as well as damage to the vehicle itself.

You will install any warning labels provided with the product so it may be prominently seen by yourself and all passengers. You will notify all passengers of the modifications performed to your vehicle prior to operation.

Insurance companies may handle coverage of a modified vehicle differently. Please check with your insurance carrier prior to modifying the vehicle to ensure your coverage remains sufficient.

Installation of this product(s) may void your vehicle warranty. If this is a concern, please check with the manufacturer or dealer before purchase or installation of this product(s).

# HIGHLIFTER

## PARTS DIAGRAM

### LIFT BRACKETS & HARDWARE (XLK-P10-B1)

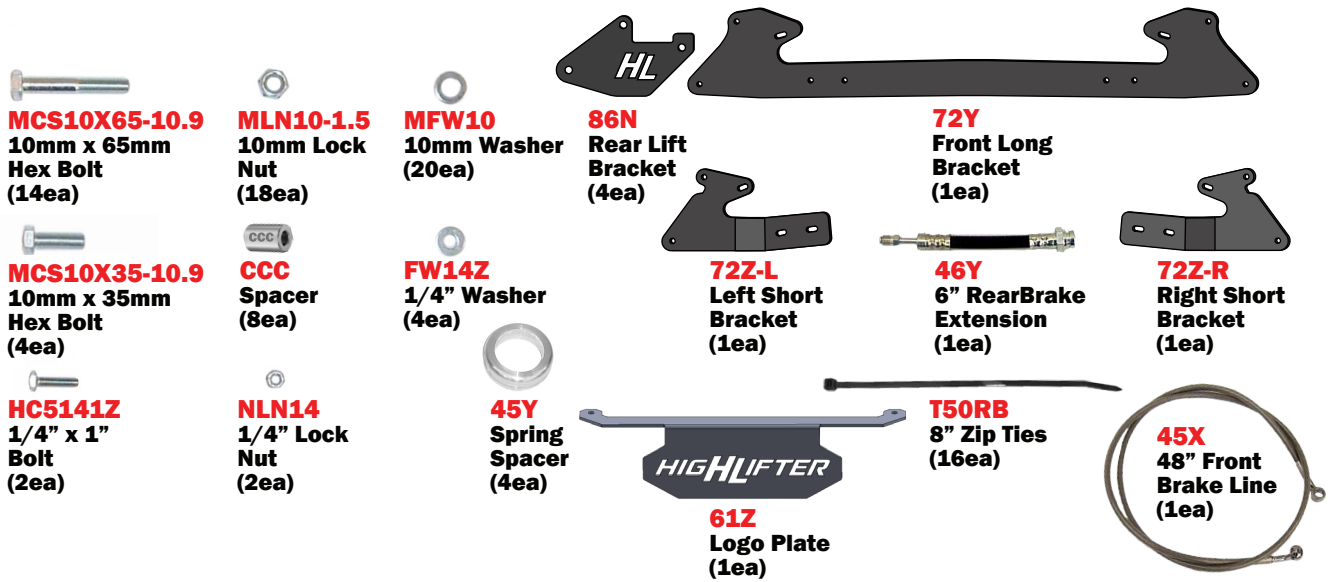

### FRONT LOWER & UPPER ARMS (HD-XLK-P001-B2)

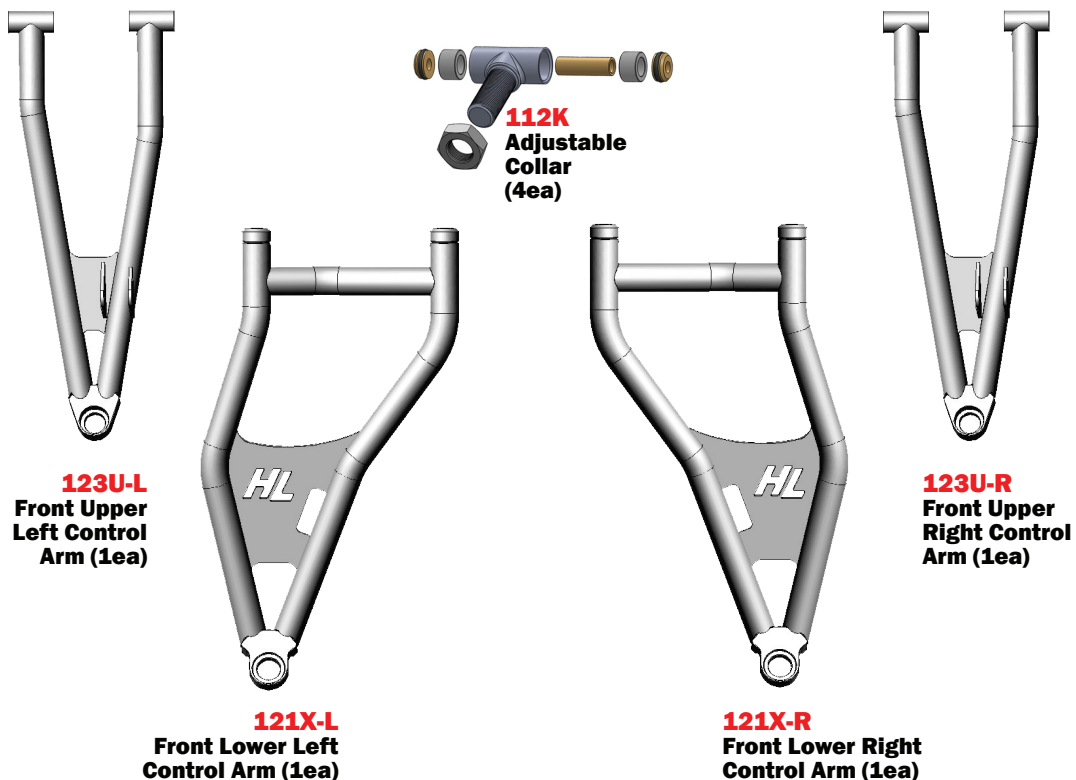

# HIGHLIFTER

## PARTS DIAGRAM

### REAR LOWER & UPPER ARMS (HD-XLK-P001-B3)

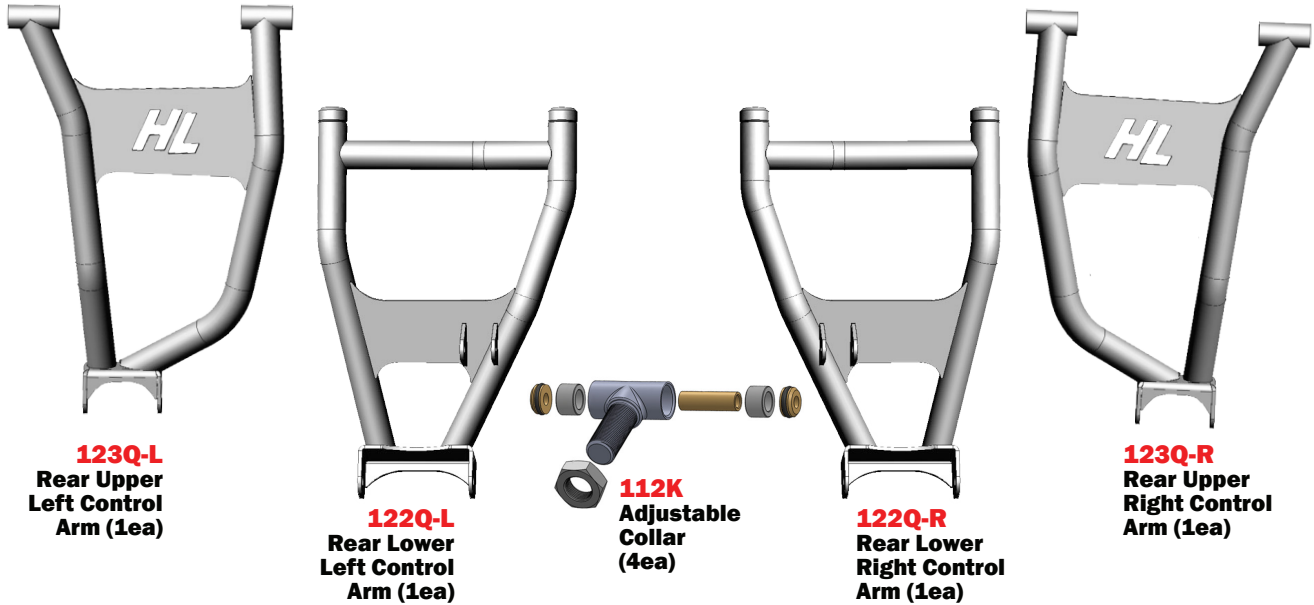

### TIE ROD & STEERING SET UP (XLK-P10-B4-2)

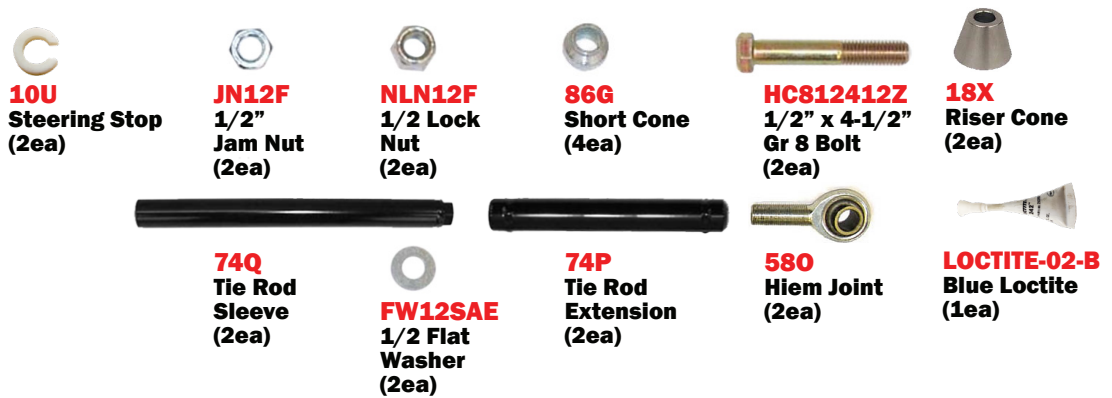

### AXLES (DHT-XL)



Front Axle (2ea)



Rear Axle (2ea)

	RNG1	RNG1-2	RNG1-3
Front	DHT-XL-RNG9-F	DHT-XL-RNG9-F	DHT-XL-RNG1-3-F
Rear	DHT-XL-RNG9-R	DHT-XL-RNG1-R	DHT-XL-RNG1-R



1



## FRONT PASSENGER SIDE

**KEEP ALL FACTORY HARDWARE.**

Place **jack** under the **FRONT center** of the UTV and lift until the weight is off the suspension. Ensure that the vehicle is properly secured, so that it is stable on the jack.

Make sure that the jack is tall enough to raise the UTV high enough to reinstall the tires after the lift is installed.

**Remove the front wheels.**

2



You will need to remove the **clamps** that hold the brake lines to the arm by **drilling off the rivets**. Then remove the brake calipers and set aside.

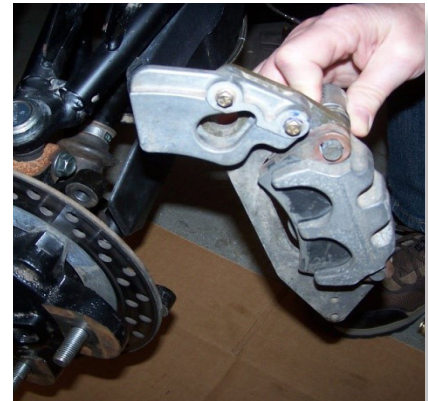

3

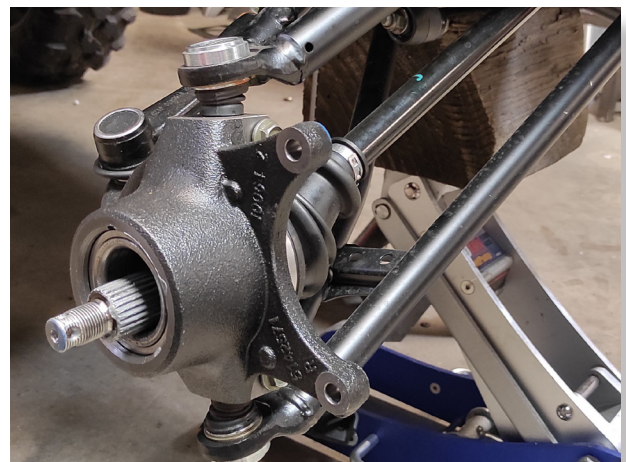
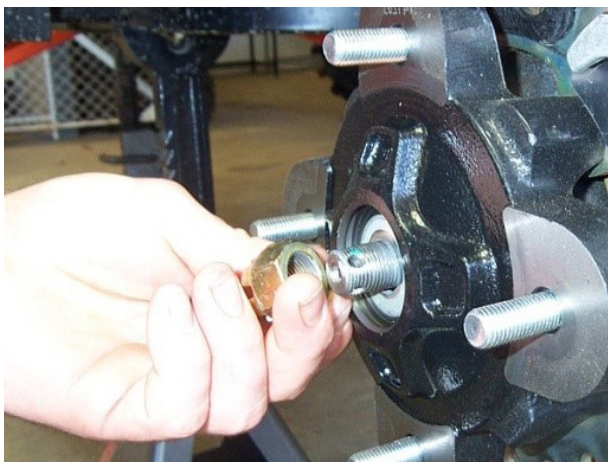

Remove the **Hub Assembly** from the arms by removing the **cotter pin, axle nut, and washers**. **YOU WILL REUSE THE FACTORY HARDWARE** to reconnect the new control arms to the frame.

4 Before removing the upper and lower arms from the front hub assembly, you will first need to disconnect:

- A. Tie rod
- B. Lower sway bar link end
- C. Lower shock end
- D. Upper Ball joint

TIE ROD



LOWER SWAY BAR MOUNT

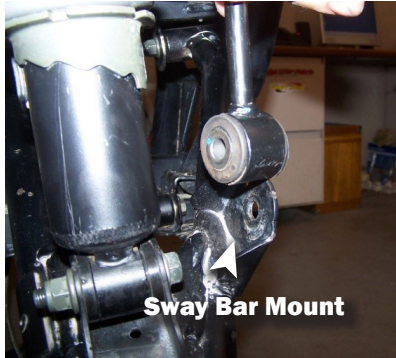

LOWER SHOCK END

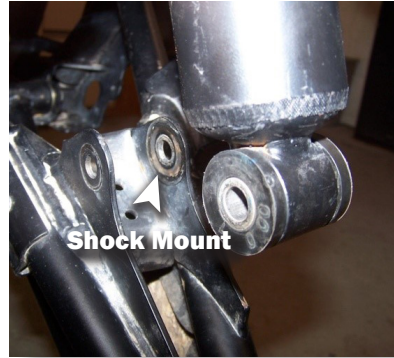

UPPER BALL JOINT

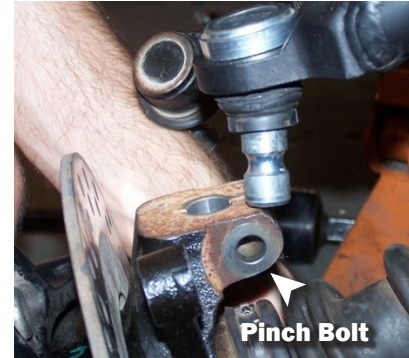

5

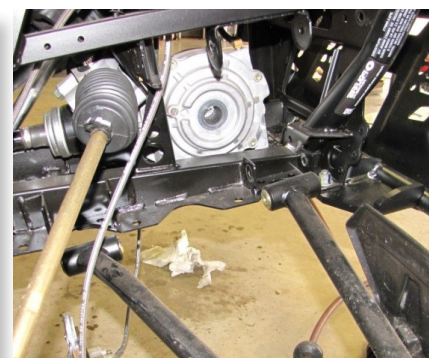

Remove the Lower Arm **FIRST** by using a 6mm hex key to hold the stud in place, then disconnect the Lower arm by removing the bolts from the frame. **KEEP ALL FACTORY HARDWARE.**



Disconnect the Upper arm by removing the bolts from the frame. **KEEP ALL FACTORY HARDWARE.**



**6 YOU WILL BE COMPLETELY REMOVING THE SWAY BAR.**

**NOTE: If you have a winch or winch plate, you may have to loosen the bolts or remove it to so you can remove the sway bar.**



Disconnect the upper end of the sway bar link.



Remove the lock nuts and bolts that attach the bar to the front frame.



Remove the front grill insert to gain access to the sway bar.

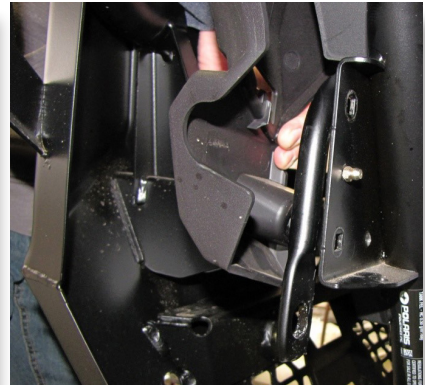
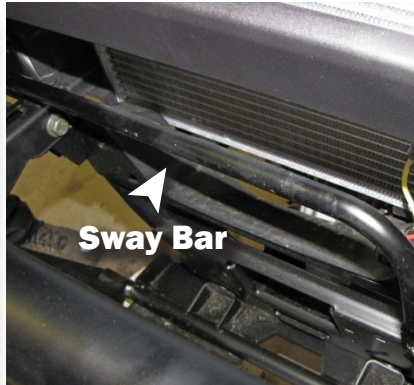
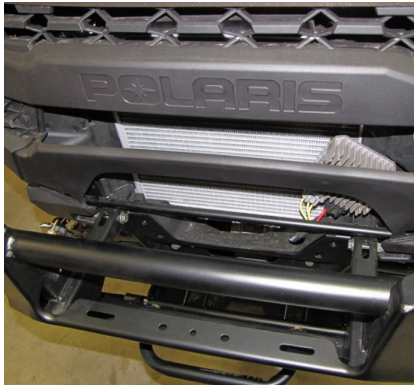

FRAME TAB

Modification

**7**

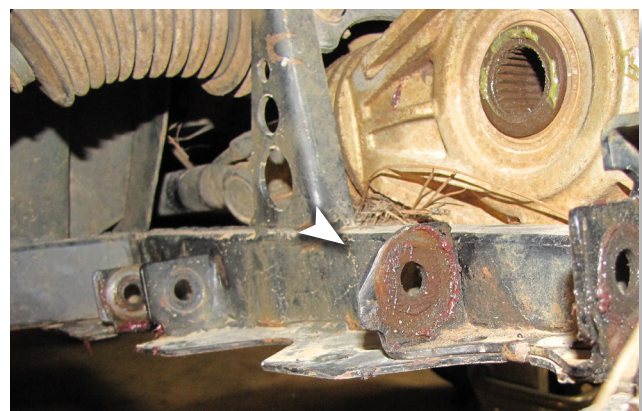

Remove the stock axles.

Using a grinder, shave down the **LEFT** tab where the **RIGHT** side of the **LOWER** arm, connects to the frame, just below the axle.



**IF YOU ORDERED PRE-INSTALLED ARMS SKIP TO STEP 10**

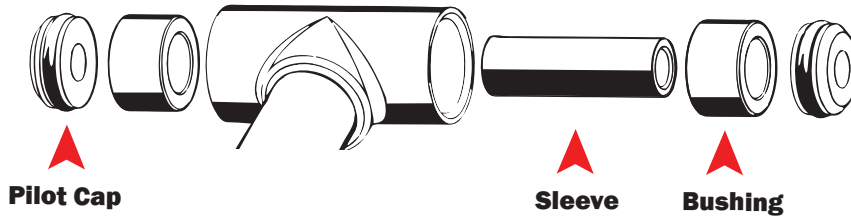

## UPPER ARM

Remove **pivot caps** and **sleeves** from both arms



**A flat punch or press is recommended to remove the bushings.**

Use caution when removing the bushing from the collar, there is a stop built into the factory arm that prevents the bushing from pushing out when installed. Because of this, the bushing must be pushed out from the opposite side.

You will need to reuse your factory pivot caps, bushings, sleeves, and ball joints. Make sure that you inspect your bushings and ball joints for wear. Replace as needed.



**112K**

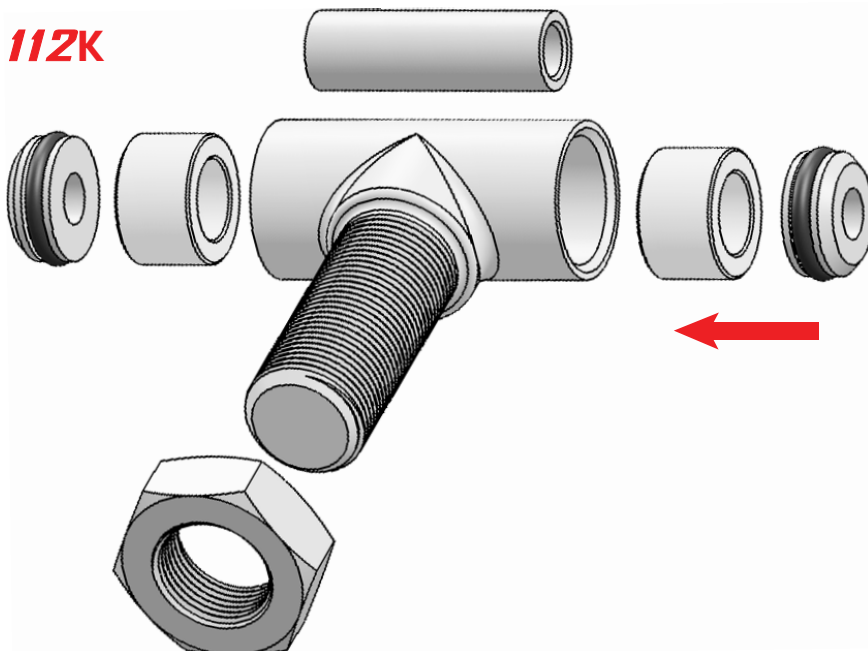

## LOWER ARM

Once the bushing is inserted, you will need to use a socket, of the same diameter of the bushing, to help press it in all the way.

**Applying grease to the bushings and sleeves will make the installation easier.**

**Use a press or vice to secure the bushings.**



10

**IF YOU HAVE PRE-INSTALLED BALL JOINTS SKIP TO STEP 12**

**NOTE: FOR DEMONSTRATIVE PURPOSES WE USED THE LOWER CONTROL ARM, BUT THE PROCESS IS SIMILAR FOR BOTH. A press or a vise is suggested for removing and replacing the ball joints.**



11

**Flip the control arm over, and using the same process, press the ball joint in using a vice or press. If you press in the ball joint crooked, DO NOT TRY TO FORCE IT IN! If you try to force it straight you can "egg" the opening. Press the ball joint out and reinsert it into the opening, pressing it in with a vise. Verify that the clip snaps into place after installing the ball joints into the new Control Arm. You should always double check the ball joint snap ring for proper fit. Even if you use snap ring pliers, it may not seat. You can use a flathead screwdriver and a hammer to tap the snap ring to ensure that it is seated into the groove.**



**BALL JOINT ORIENTATION**

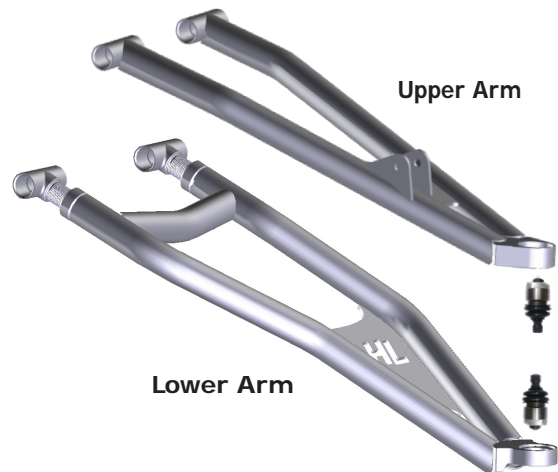

Snap the retaining clip down on to the base of the ball joint.

12



**REMOVE SHOCK FROM UTV.**

**BEFORE STARTING**

- Spring spacers are optional, depending on the desired ride quality, they may not be needed.
- You will need a spring compressor to install the spring spacers onto the factory shocks.
- Adding Spacers will stiffen the ride of the vehicle.

**Remove the spring retainer and stock spring from the shock.**



**Place the spring spacer (45Y) onto the shock between the adjustment cam and the spring.**

**Place the spring back on the shock, compress it, and then reinstall the spring retainer.**

**THE PROCESS WILL BE THE SAME FOR THE REAR SHOCKS.**

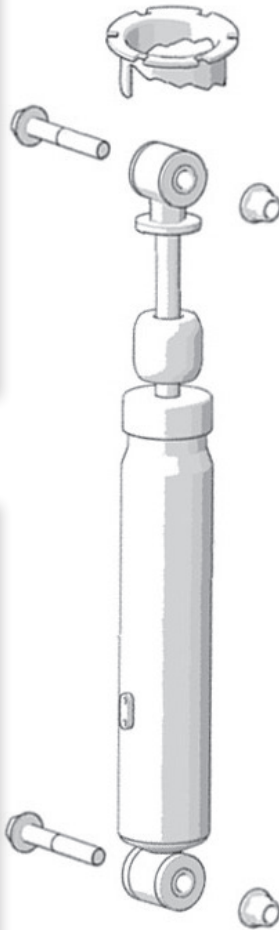



# 13 RIGHT PASSENGER SIDE

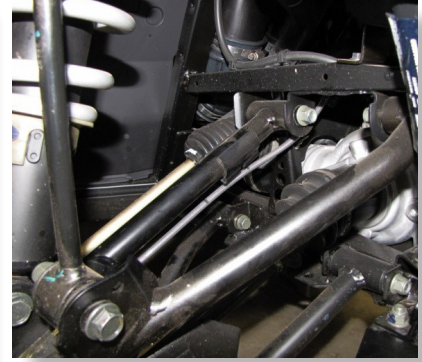
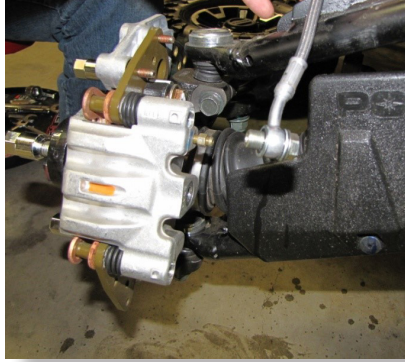

Disconnect the brake line from the caliper and free the line from any retaining clips or ties that hold it in place on the right side upper control arm.

## LEFT DRIVERS SIDE

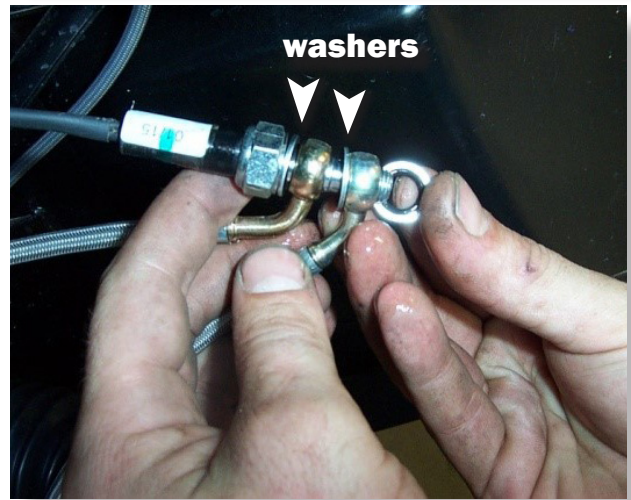
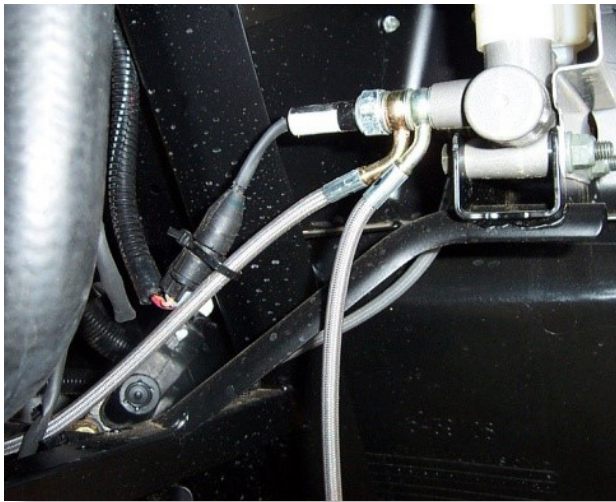

Disconnect the line from the master cylinder

Save the factory washers that separate the two front lines. Remove the line from the UTV.



# 14 RIGHT PASSENGER SIDE



Install the new longer 48" brake line (45X) on the right side of the UTV.



Route the line back through to the right front control arm caliper and reconnect it with the factory hardware.

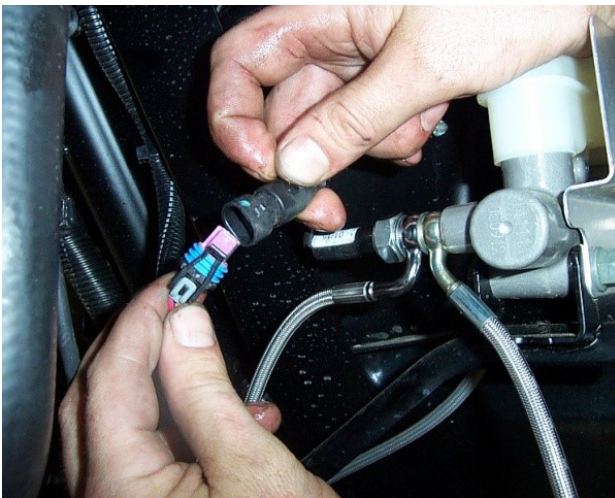
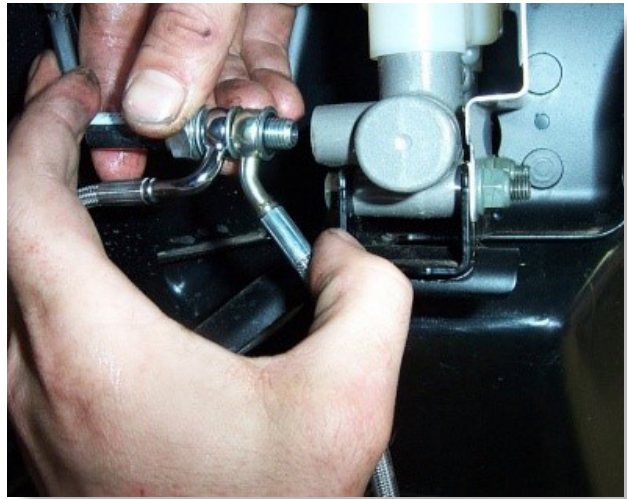
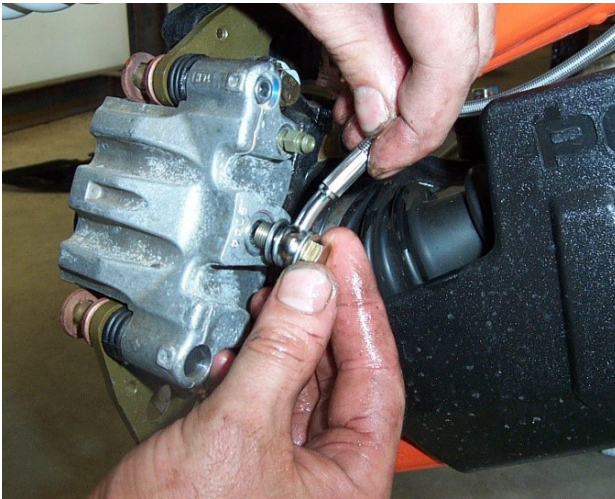

Use the right factory brake line that you removed to replace the left factory brake line. The left factory line will not be long enough once the new control arms are installed. Then connect all the lines back to the master cylinder using the factory hardware.



15



Before you insert the long lift bracket (72Y) into the center of the UTV, you will need to unclip some wires from around the upper shock mount tabs. These can interfere with the installation.



Run the long front lift bracket (72Y) behind the wires and along the frame support bars to the other side. You will insert the bracket into the center of the two shock mount tabs on both sides of the UTV.

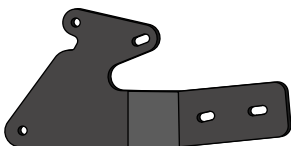
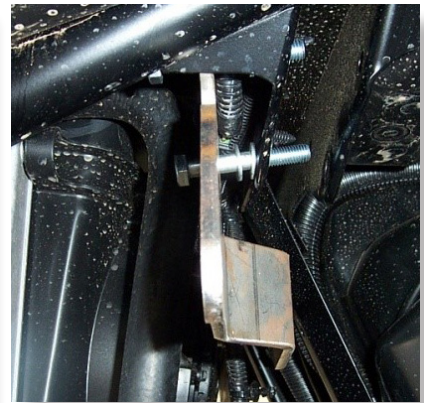
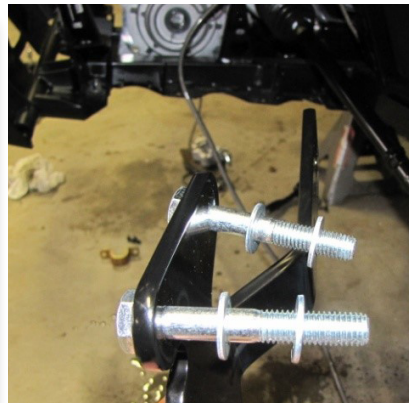

Place the left lift bracket (72Z-L) to the outside of the front shock mount tab. It needs to be on the side that faces the front of the UTV. Connect the bracket using (2) 10x65mm hex bolts) and (4) 10mm flat washers).



16

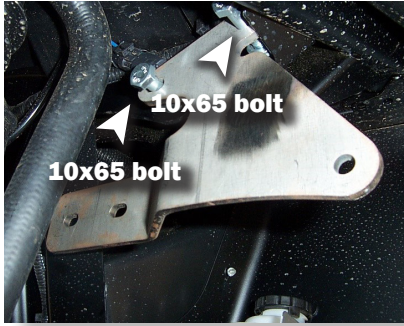

10x65 bolt  
10x65 bolt

Insert the two bolts through the bracket, then place two washers on each bolt. Insert the bolts through the shock mount tabs.

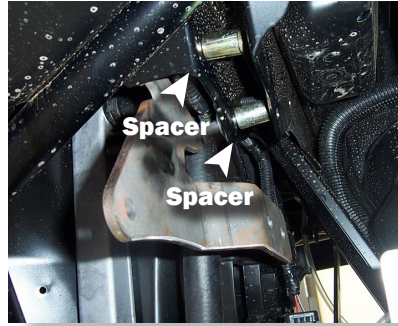

Spacer  
Spacer

Insert a spacer (CCC) on each of the bolts. Now place the front long lift bracket to the inside of the inner shock mount tab. Push the two bolts all the way through and loosely fasten it with (two 10mm lock nuts).

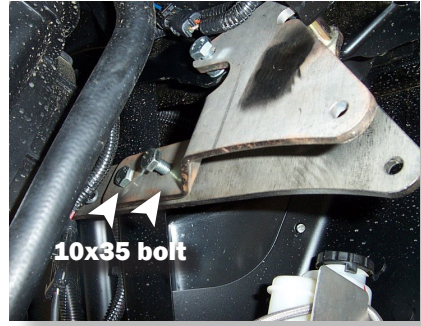

10x35 bolt

Use (two 10mm x 35mm bolts) to secure the short front lift brackets to the long front lift bracket.

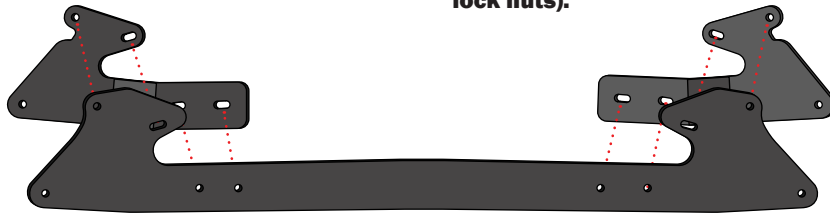

Insert the bolts from the front to the back and fasten them with the (10mm lock nuts) provided.

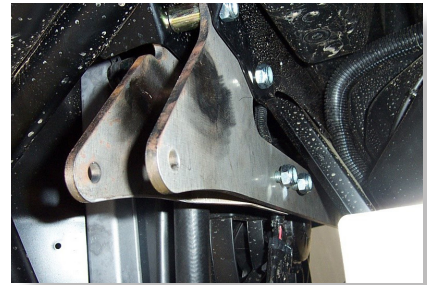

**DO NOT** connect the top of the shock at this time.

Repeat the steps for the opposite side. fasten all hardware tight.

17

STOCK TIE ROD



Disconnect outer tie rod end & remove jam nut.



Slide the tie rod sleeve (74Q) over the factory tie rod.



Thread on the tie rod extension (74P) and tighten it.

MODIFICATIONS

(LEFT HAND THREADED)

HEIM JOINT (580)  
(RIGHT HAND THREADED)



LEFT HAND THREADED

RIGHT HAND THREADED



Bevelled



Rounded



Install the heim joint (580) and jam nut (JN12F) to the opposite end. This will likely need to be adjusted later.

18

**NOTICE: DO NOT remove the pinion. The images featured are for DEMONSTRATIVE PURPOSES ONLY.**

### BOOT REMOVAL

The rubber boots on the rack and pinion are held on by zip ties. You will need to cut the zip tie that secures the boots to the inside of the rack and pinion.

### START WITH THE DRIVER'S SIDE

This side has the least amount of room. Once you install the spacer on the passenger side you will have less play on the driver's side. **DO NOT REMOVE THE FACTORY SPACER ALREADY IN PLACE.** Turn the steering wheel all the way to the **RIGHT**.

### PASSENGER SIDE

Turn the steering all the way to the left. Place the **steering stop (10U)** between the inner tie rod joint and the rack and pinion. It is a tight fit, so you may have to force it on, this is to ensure that the spacer stays in place.

### RESECURING BOOT

you will need to turn the steering wheel closer to the center to allow play in the boot. Slide the boot back down and secure it with an 8" zip tie.

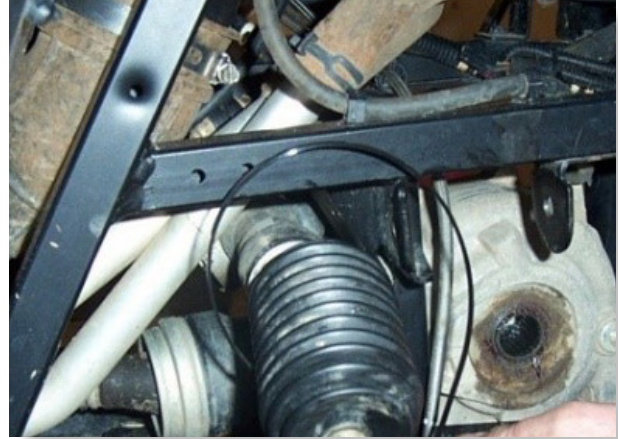
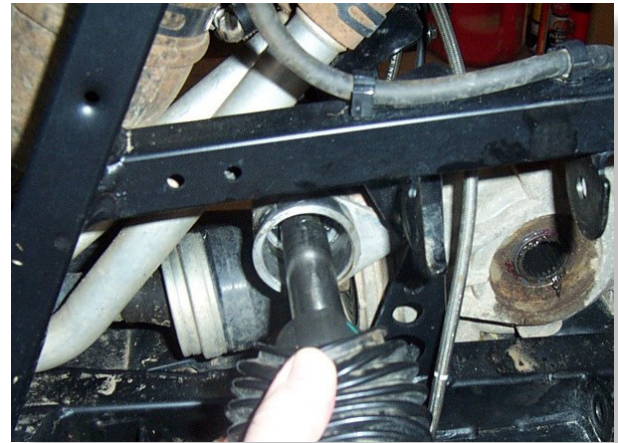
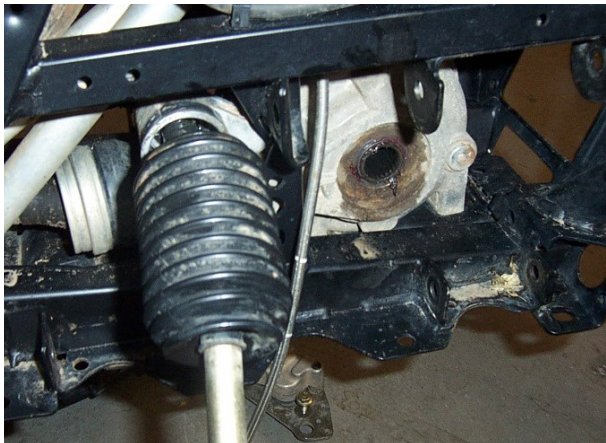
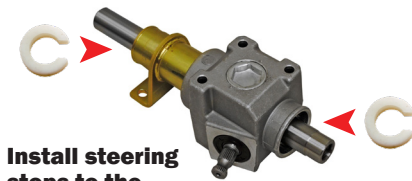



19



Install the axles, then connect the new lower arm (121X) to the frame using the factory hardware. Connect the arm at the pinch bolt on the knuckle **FIRST** and slide the axle through **AFTER**. Secure with factory hardware.

20



Using factory hardware, connect the new upper arm to the frame, then at the pinch bolt on the knuckle. Connect the lower shock tab **LAST**.

Washer Washer  
Bolt Nut

Insert the 10mm x 65mm bolt through the upper shock lift bracket, then slide it through the (2) 10mm washers, then secure it with a 10mm lock nut.



21

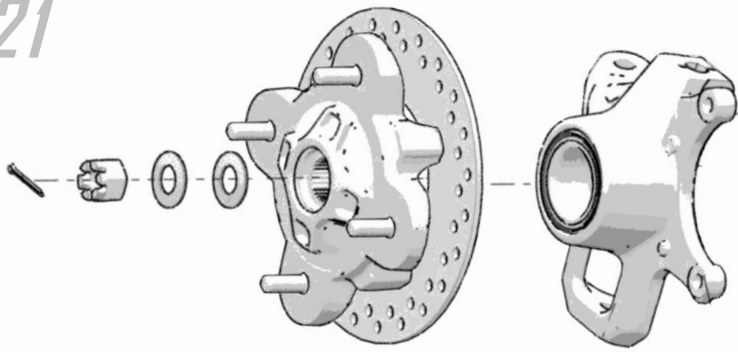

Reattach the rotor to the knuckle assembly.

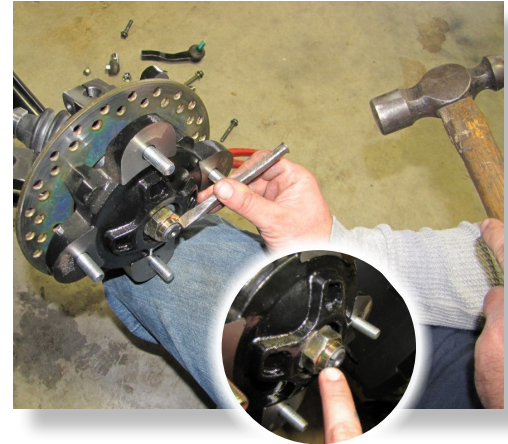

22

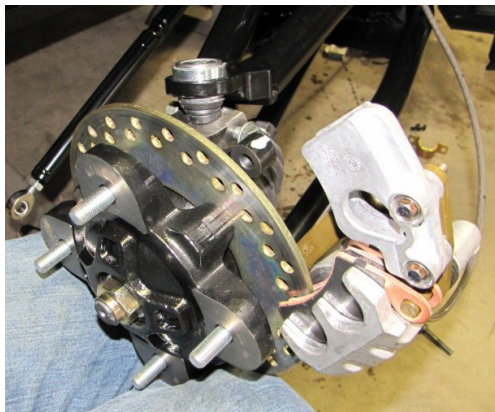

Use the 3 (8" zip ties) along the back of the upper control arm.

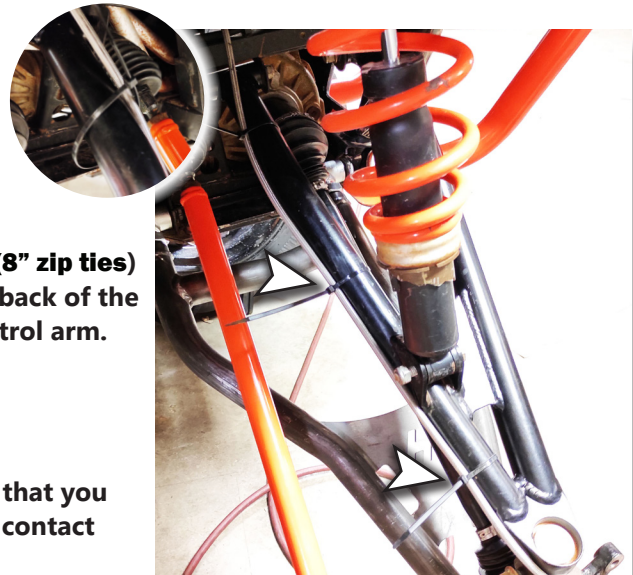

Connect the caliper to the hub assembly. Make sure that you re-route the brake lines, so that they do not come in contact with moving parts and don't become pinched.

23

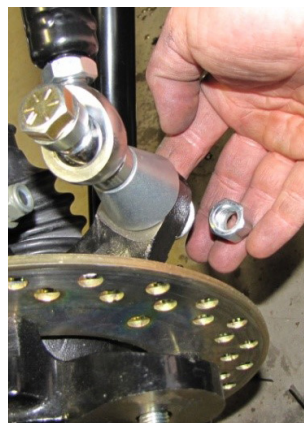

Use a 1/2" drill bit to drill out the factory hole where the original tie rod connected. Slide the (1/2" x 4 1/2 bolt) through the alignment bushing (86G), the heim joint (580), the second cone (86G) and the riser cone (18X), then insert that through the knuckle assembly and fasten with a 1/2 flat washer followed by a 1/2 lock nut.

REPEAT STEPS FOR OPPOSITE SIDE

24



**REAR PASSENGER SIDE**

**KEEP ALL FACTORY HARDWARE.**

Place **jack** under the **REAR center** of the UTV and lift until the weight is off the suspension. Ensure that the vehicle is properly secured, so that it is stable on the jack.

Make sure that the jack is tall enough to raise the UTV high enough to reinstall the tires after the lift is installed.

**Remove the rear wheels.**

25

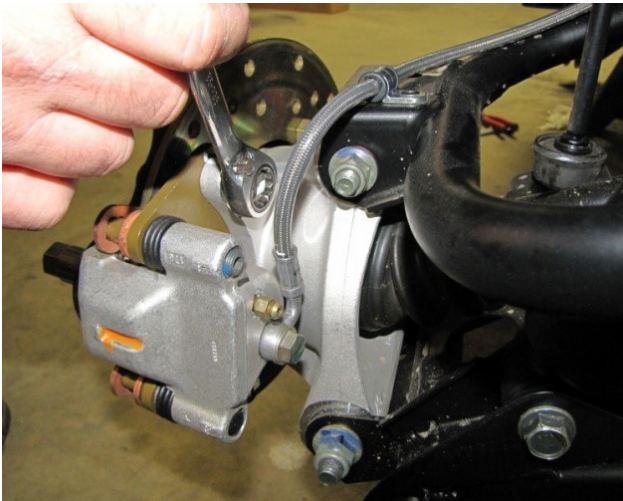

**Disconnect the brake caliper from the hub assembly, leave the brake line attached to the caliper. Unclip the brake line from the lower control arm and set brake caliper aside.**

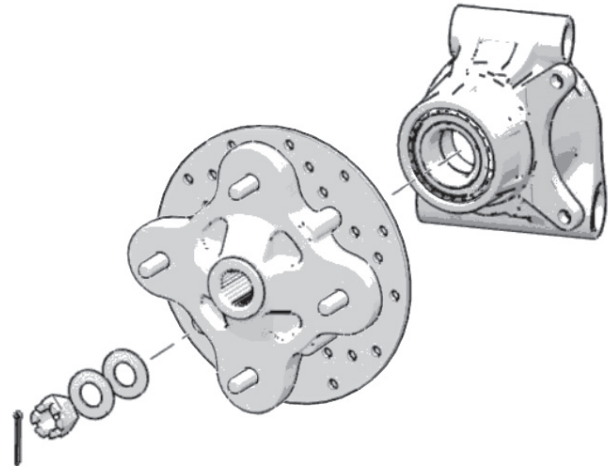

**Remove the factory cotter pin and castle nut on the rear axles, then remove the brake rotor assembly.**

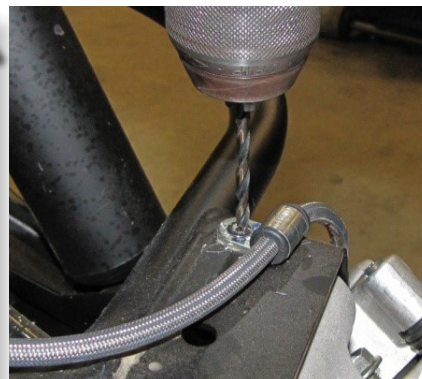

**Drill out the factory p-clamps until they snap off, then remove the clamps from the upper arm.**



# 26 LOWER ARM

Disconnect the lower arm **FIRST** by detaching the arm at the hub, then disconnect the lower shock, sway-bar, and frame bolts. The factory hardware will be used to reconnect the new control arms.

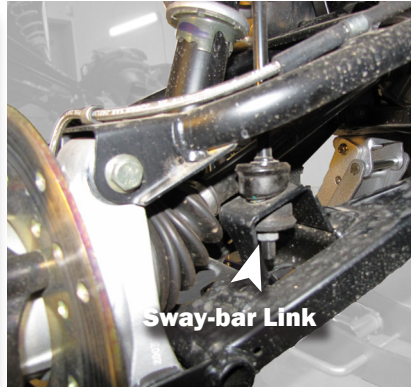
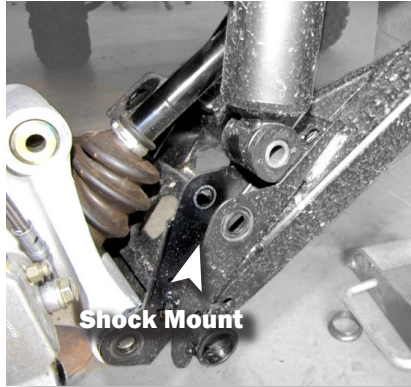

# UPPER ARM

For Northstart And High Lifter editions, remove the exhaust. This will help with sway bar removal and gain access the upper control arm bolt.

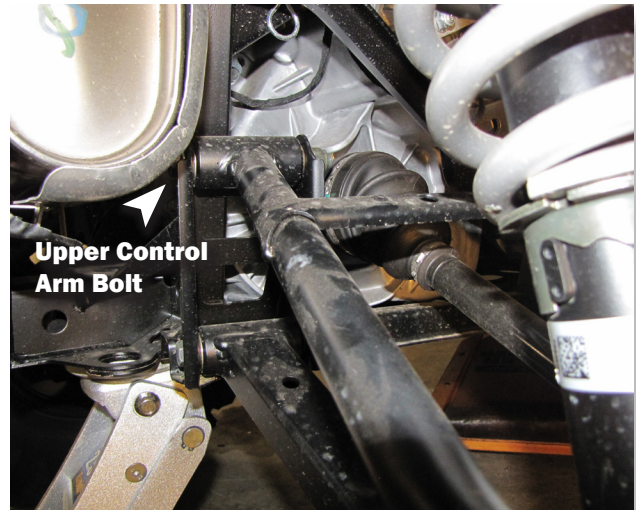
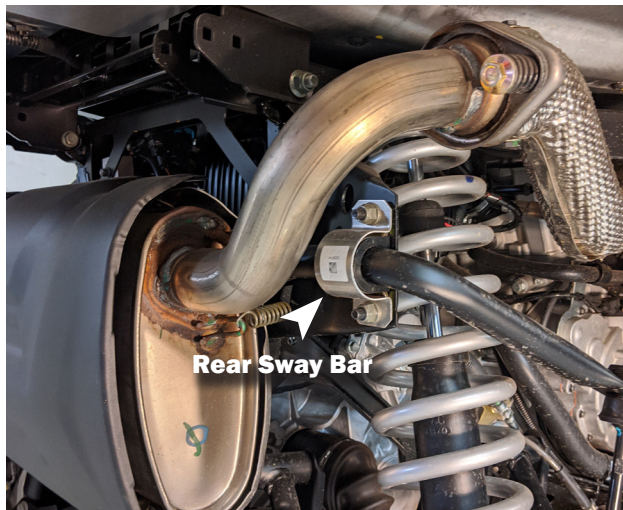

Remove the upper control arm and stock axles at this time.

27

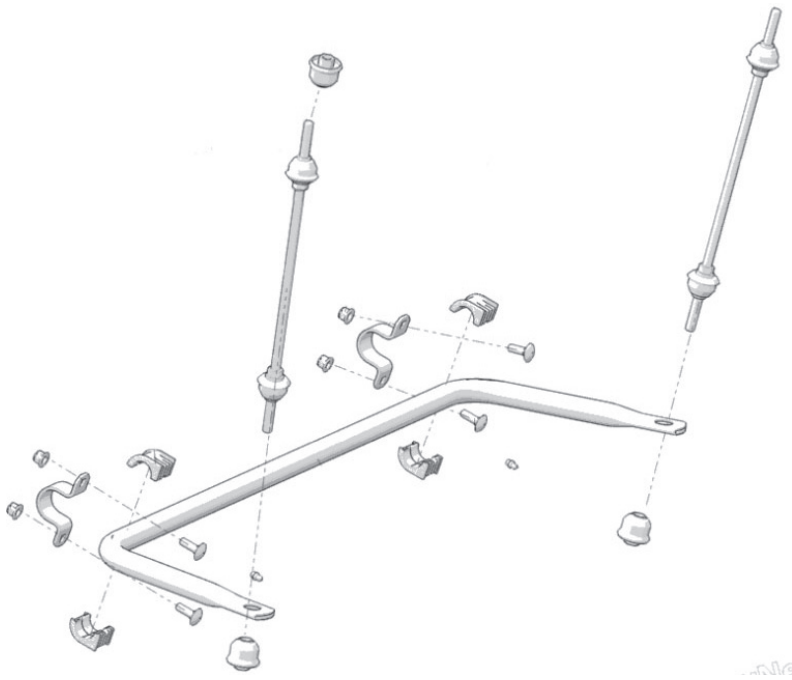

Remove the nuts that secure the sway bar to the sway bar rod. **COMPLETELY REMOVE THE SWAY BAR, sway bar connecting brackets, and rods from the UTV.** They are not used in conjunction with the big lift kit.

28

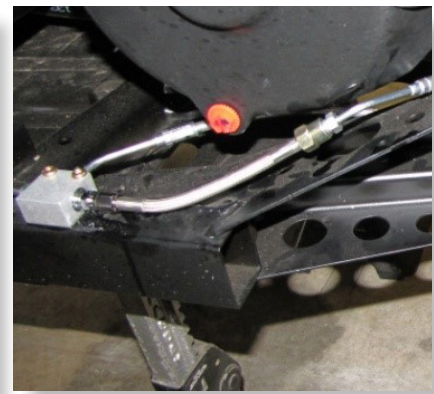
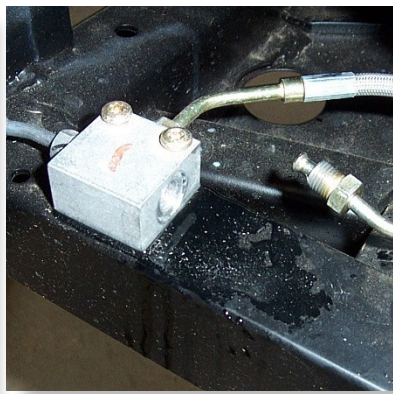

Locate the brake line junction fitting on the rear lower left side or driver side of the frame. Disconnect the line from the junction fitting. Connect the new 6" extension (46Y) to the brake line. **NOTE:** It may be necessary to reroute the lines if they become pinched.



**6" Extension (46Y)**



# 29 LOWER ARM

REFER TO PAGE 7 & 8 FOR BALL JOINT INSTALL & ADJUSTABLE COLLAR INFORMATION.



Install the new rear axles into the differential.

Install the new APEXX lower control arm (122Q-R) to the frame, using the factory hardware. **DO NOT FORGET WASHERS.**



# UPPER ARM

REFER TO PAGE 7 & 8 FOR BALL JOINT INSTALL & ADJUSTABLE COLLAR INFORMATION.



Install the new APEXX upper control arm (123Q-R) to the frame, using the factory hardware. **DO NOT FORGET WASHERS.**

**WHEN INSTALLING THE UPPER ARM TO THE LEFT FRAME TAB, INSTALL THE BOLT FROM THE RIGHT SIDE TO EASE FUTURE MAINTENANCE.**



(If installed from the opposite direction, the exhaust will continue to block bolt removal)

30



slide the hub assembly over the axle end. Connect the upper and lower arms to the hub assembly using the factory hardware.



Place the rotor onto the hub and axle assembly. Fasten the rotor using the axle washers, castle nut, and cotter pin provided in the kit.



REPEAT STEPS FOR OPPOSITE SIDE

31 DRIVER'S SIDE

THE SAME STEPS APPLY FOR EACH SIDE



Place one rear lift bracket (86N) to the outside of the rear shock mount. It needs to be on the side that faces the front of the UTV.

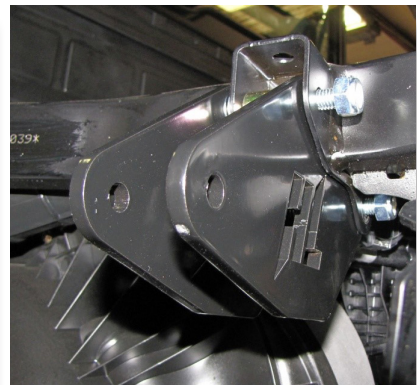
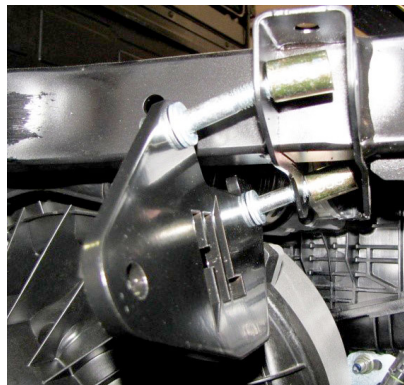

Connect the bracket using (2) 10x65mm hex bolts). Place (2) 10mm washers on each bolt then insert the (2) bolts through the bracket. Insert the bolts through the shock mount tabs. Insert a spacer (CCC) on each of the bolts and another 86N rear lift bracket to the inside of the outer shock mount tab. Loosely fasten it with (2) 10mm lock nuts.

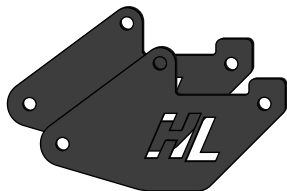

REAR LIFT BRACKET (86N)

There are left and right plates. The logos on the plates should be legible from the rear of the vehicle.

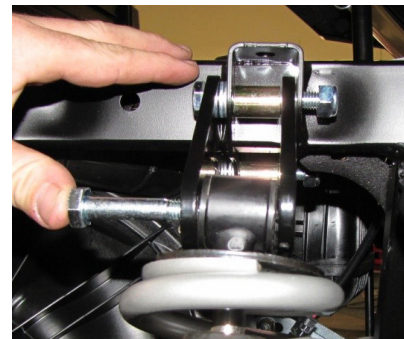

Connect the top of the shock to the lift brackets using one (10x65mm bolt) and (10mm lock nut).



Use the 10mm x 65mm bolt to connect the lower portion of the shock to the control arm.



32

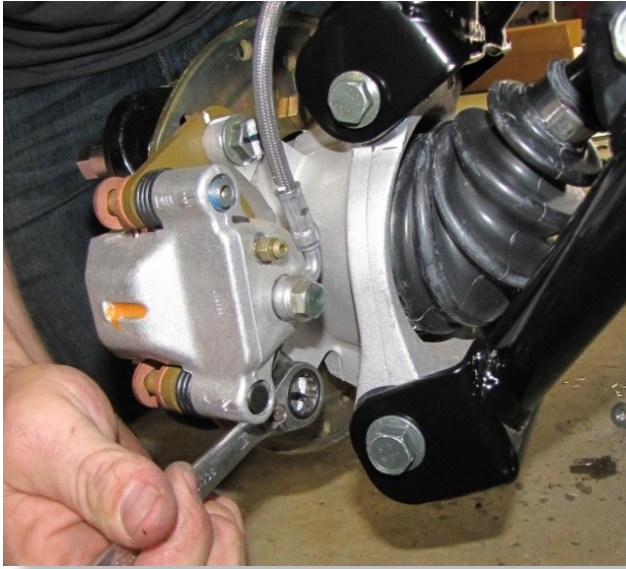

**Fasten the caliper to the hub assembly.**

**Make sure that you run the brake lines in a manner that they do not come in contact with moving parts and become pinched.**

## 33 REAR PASSENGER SIDE

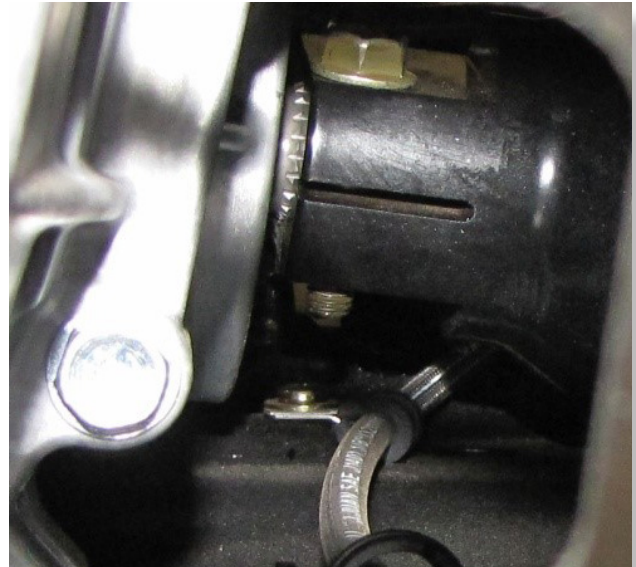
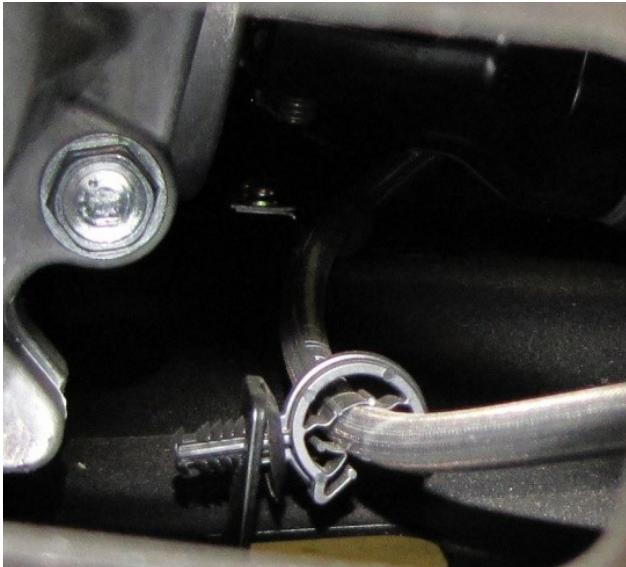

**Run the slack out where the brake line runs under the rear differential. Make sure the line is still running through the two clamps attached to the bottom and clear from contacting the rear drive shaft.**

34



Secure the rear brake line to the front of the upper control arm using 3 (8" zip ties)

Place the wheels back on the Ranger and torque lugs to factory specifications.



**REPEAT STEPS ON OPPOSITE SIDE**

35

Lift the bed to gain access to the rear frame bracket.



Disconnect and unclip the wire. Slide the logo plate (61Z) between the frame bracket and the bed.



Slide a (1/4" x 1" bolt) and (1/4" washer) through the logo plate, into each hole on the frame.



Fasten the bolts with a (1/4" washer) and (1/4" lock nut). Reconnect the wire.



## 36 FRONT WHEEL ALIGNMENT

When you have completed the tie rod installation on both sides you will need to adjust the tie rod to achieve the proper alignment. **DO NOT INSTALL WHEELS ON UTV UNTIL ALIGNMENT HAS BEEN CHECKED.**

- Make sure that the brake rotors are straight to sight or level.
- Make sure that the steering wheel is straight to sight.
- Take a tape measure and measure from inside to inside on the front and back ends of the rotors.
- They must both be the same distance. If they're not, then tie rods will need adjusting in or out.

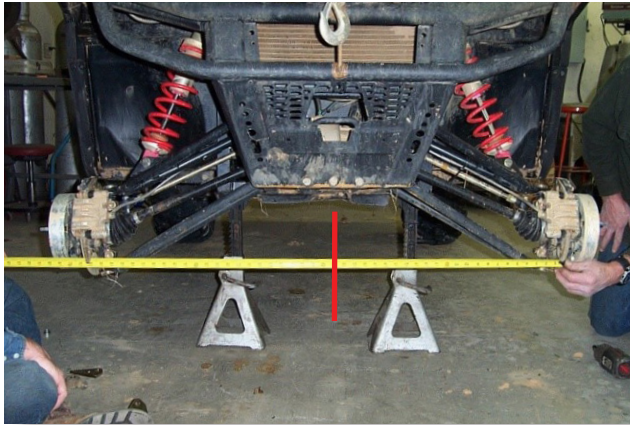

### INCORRECT TOE

If the toe alignment is incorrect, measure the distance between vehicle center and each rotor. This will tell you which tie rod needs adjustment.

### ADJUSTING TOE

When adjusting the toe, be sure to take the time to adjust both ends half the required distance. A slight toe out (1/8 to 1/4) makes the steering less sensitive and the UTV more stable. To adjust the toe alignment, hold the tie rod end to keep it from rotating. Loosen the jam nuts at both ends of the tie rod. Shorten or lengthen the tie rod (screw it in or screw it out) until alignment is met and the proper 'Toe Out' front setting is achieved.



**IMPORTANT NOTE:** When tightening the tie rod end jam nuts, the tie rod ends must be held parallel to prevent rod end damage and premature wear. Damage may not be immediately apparent if done incorrectly.

Once steps are complete, place the tires back on the UTV and torque lugs to factory specifications. Inspect all nuts and bolts to ensure they are all tight before proceeding.

### 37 BEFORE STARTING

- Tires must be off the ground
- Tires must have equal air pressure
- Suspension components must be completely assembled

The new High Lifter lower control arms will come pre-adjusted to factory length, which is .937

If you need to re-adjust the collars, place the factory arm and new control arm on a flat surface. Measure from eyelet to center mount on the factory arm, and then adjust the new arms to those lengths.

**NOTE:** When re-adjusting, leave the jam nuts loose. Do not fasten tight until installed on UTV, after all final adjustments have been made.

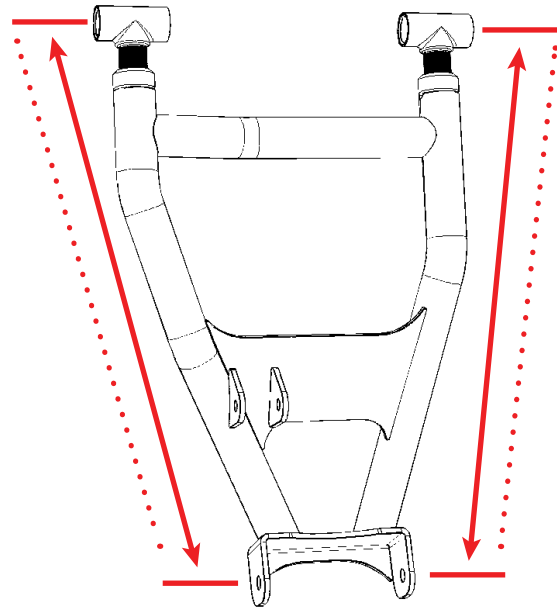

### Positive Camber

If you have a positive camber you will need to adjust the collar **OUTWARD** or lengthen the collar.

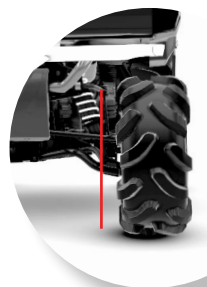
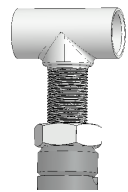

### Correct Camber

For this application, we recommend a camber setting of 0°. Collars are preset to .937

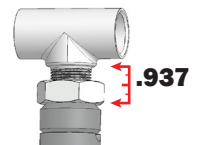

Make all adjustments in small increments.

Do this by disconnecting control arms at the frame and adjusting collars. Once small adjustments have been made. Take the UTV off the jack and roll it back and forth several times to check the camber. Repeat steps as needed. After alignment is complete, tighten jam nuts to 80 ft-lbs and secure it with blue loctite.



### Negative Camber

If you have a negative camber you will need to adjust the collar **INWARD** or shorten the collar.



38

**IF YOUR STEERING IS ALREADY CENTERED THEN YOU WILL NOT HAVE TO FOLLOW THESE NEXT STEPS.**

Factory steering for the Polaris Ranger 1000 may **NOT** be centered. This can cause the tie rod ends to have more engagement on one end than the other. This also causes the steering wheel to be off center.



**A)** When the steering is zeroed, check the steering wheel to make sure that it is properly positioned.



**(B)** If the steering wheel is not centered, you will need to remove the center cap with a flat head screwdriver to gain access to the steering wheel nut.



**(C)** Using a ratchet, turn the steering nut counter clockwise or left. Continue this until the steering wheel locks at full turn, then loosen the nut. **Do not remove the nut yet.**



Once the nut is broke, back it off just enough leaving a few threads. Use a hammer to tap on the nut while pulling up on the steering wheel until it breaks loose. But **DO NOT** hammer too hard, it could damage the nut or threads. Now remove the nut and steering wheel.

**NOTE:** A puller may be needed to remove the steering wheel if it can't be broken free.

Now will be the time to adjust the steering wheel accordingly. Re-place the wheel and make sure the wheels are turned back straight. The steering wheel should be straight up and down.

**NOTE:** Rolling vehicle back and forth may help straighten the wheels.

Once the wheel is straight, thread the nut back on and turn the nut clockwise until the steering wheel locks at full turn, then tighten the nut. Reinstall the steering wheel cap.

**NOTE:** Loctite may be needed for the steering nut.





## HIGH LIFTER LIMITED LIFETIME WARRANTY

High Lifter offers a Limited Lifetime Warranty to the original purchaser that our product shall be free from defects in material and workmanship for the life of the product if utilized in accordance with the manufacturer's instructions for installation and operation of said products.

### LIMITED LIFETIME WARRANTY EXTENDS TO THE FOLLOWING PRODUCT LINES:

- **Lift Kits (Signature, Standard and Big Lifts)**
- **Control Arms**
- **Trailing Arms**
- **Radiator Relocation Kits**
- **Portal Gear Lifts**
- **Wheel Spacers**
- **Tow Hooks**
- **Control Arm Link Kits**

Damages to vehicle or any other object during the installation, use, or removal of High Lifter products are not covered under this warranty. Normal wear items included with any of the products covered under this Limited Lifetime Warranty are excluded from coverage. These items include, but are not limited to heim joints, tie rods, bearings, bushings, seals, gaskets, zinc plating, painted and powder coated finishes. Other exclusions of coverage under this warranty include, but are not limited to: damage or product failure due to improper installation, lack of maintenance, product modification, abuse, collision or use on vehicles for which product was not designed, repairs performed by anyone other than approved High Lifter personnel or made using non-High Lifter components. This warranty is valid for the original purchaser only and is non-transferable. High Lifter reserves the right to inspect any product before determining if the claim is valid and covered under this warranty. Claims determined to be caused by reasons other than a manufacturer defect will be rejected and an estimate for repair or cost of a replacement product if a repair is not possible, will be provided.

**This warranty is exclusive and is in lieu of any implied warranty of merchantability, fitness for a particular purpose or other warranty of quality, whether express or implied, except the warranty of title.**

### WARRANTY PROCESSING

If you suspect your product is defective, **DO NOT** disassemble the product to determine the cause without prior approval as it may void your warranty status. This is especially true with our Portal Gear Lift. To begin the claim process, please e-mail our warranty team at [warrantycare@highlifter.com](mailto:warrantycare@highlifter.com) and include the following in the e-mail:

- Your full name, address and contact phone number.
- The year, make and model of your vehicle
- The part number of the product
- Photos of the product installed, and vehicle product is installed on
- Proof of Purchase (Required for all warranty claims and you must be the original purchaser)

Once a claim is created, you will receive a return authorization number (RMA). Write this number on the outside of the box containing your defective product and include it along with your name and contact information inside the box. Product must be returned in the original box or a box of equal strength and packaging. Product sent without an RMA number visible on the outside of the box or sent COD will be refused. Ship your product to the following address:

**High Lifter Products, Inc.**  
**Attn: Returns 780 Professional Dr N Shreveport, LA 71105**

Once your product is received, we often have your replacement or repaired product shipped back to you within 3-business days of receiving it. Please note that High Lifter is not responsible for shipping charges on product returned for warranty or repair, including duties and fees required by those residing outside the United States.

**THANK YOU FOR CHOOSING**  
**HIGHLIFTER**



## DHT-XL BIG LIFT AXLE WARRANTY PROGRAM

Thank you for purchasing a High Lifter Products Big Lift equipped with a set of DHT-XL Big Lift Axles. Our axles have been engineered to provide superior performance for use on your ATV/UTV.

### HIGH LIFTER DHT X & DHT XL AXLE 18-MONTH LIMITED WARRANTY

High Lifter offers an 18-Month Limited Warranty to the original purchaser that our DHT X and DHT XL line of axles shall be free from defects in material and workmanship for 18-months following the original purchase date if utilized in accordance with the manufacturer's instructions for installation and operation of said products. In the event of a failure during this 18-month period, High Lifter will replace the axle one time free of charge. Subsequent replacements during this 18-month period will be charged a \$50.00 replacement fee.

### HIGH LIFTER CV AXLE 12-MONTH LIMITED WARRANTY

High Lifter offers an 12-Month Limited Warranty to the original purchaser that our CV line of axles shall be free from defects in material and workmanship for 12-months following the original purchase date if utilized in accordance with the manufacturer's instructions for installation and operation of said products. In the event of a failure during this 12-month period, High Lifter will replace the axle one time free of charge. Subsequent replacements during this 12-month period will be charged a \$50.00 replacement fee.

### HIGH LIFTER STOCK SERIES AXLE 90-DAY LIMITED WARRANTY

High Lifter offers an 90-Day Limited Warranty to the original purchaser that our Stock Series line of axles shall be free from defects in material and workmanship for 90 days following the original purchase date if utilized in accordance with the manufacturer's instructions for installation and operation of said products. In the event of a non-defect related failure during this 90-day period, High Lifter will offer to replace axle for a \$40 replacement fee.

Damages to vehicle or any other object during the installation, use, or removal of High Lifter products are not covered under this warranty. Damage or product failure due to improper installation, lack of maintenance, product modification, abuse, collision or use on vehicles for which product was not designed are also excluded from coverage. Other exclusions of coverage under this warranty include, but are not limited to: damage or product failure due to improper installation, lack of maintenance, product modification, abuse, collision or use on vehicles for which product was not designed, repairs performed by anyone other than approved High Lifter personnel or made using non-High Lifter components. This warranty is valid for the original purchaser only and is non-transferable. High Lifter reserves the right to inspect any product before determining if the claim is valid and covered under this warranty. Claims determined to be caused by reasons other than a manufacturer defect will be rejected and an estimate for repair or cost of a replacement product if a repair is not possible, will be provided.

This warranty is exclusive and is in lieu of any implied warranty of merchantability, fitness for a particular purpose or other warranty of quality, whether express or implied, except the warranty of title.

### WARRANTY PROCESSING

If you suspect your product is defective, **DO NOT** disassemble the product to determine the cause without prior approval as it may void your warranty status. To begin the claim process, please e-mail our warranty team at [warranty@highlifter.com](mailto:warranty@highlifter.com) and include the following in the e-mail:

- Your full name, address and contact phone number.
- The year, make and model of your vehicle
- The part number of the axle
- Photos of the axle installed, and vehicle axle is installed on
- Proof of Purchase (**Required for all warranty claims and you must be the original purchaser**)

Once a claim is created, you will receive a return authorization number (RMA). Write this number on the outside of the box containing your defective product and include it along with your name and contact information inside the box. Product must be returned in the original box or a box of equal strength and packaging. Product sent without an RMA number visible on the outside of the box or sent COD will be refused. Ship your product to the following address: **High Lifter Products, Inc. Attn: Returns 780 Professional Dr N Shreveport, LA 71105** Once your product is received, we often have your replacement or repaired product shipped back to you within 3-business days of receiving it. **Please note that High Lifter is not responsible for shipping charges on product returned for warranty or repair, including duties and fees required by those residing outside the United States.**



### HIGH LIFTER PRODUCTS DHT-XL AXLE WARRANTY

Name: \_\_\_\_\_ Axle Product Number: \_\_\_\_\_  
Address: \_\_\_\_\_ Place of Purchase: \_\_\_\_\_  
\_\_\_\_\_  
Date of Purchase: \_\_\_\_\_  
Phone Number: \_\_\_\_\_ Reason for Return: \_\_\_\_\_  
E-Mail Address: \_\_\_\_\_  
\_\_\_\_\_

Reminder – This claim must be accompanied by a copy of the original receipt.

